Caderno Técnico

Projeto Executivo de
Sinalização Vertical Indicativa
Turística de Cabreúva

Arquiteta e Urbanista
Elionai de Godoy Ferreira

Introdução

O presente caderno técnico é apresentado para detalhamento e especificações do projeto de Sinalização Turística do município de Cabreúva.

Neste se encontram as cores, fixações, suportes, posicionamento e especificações técnicas dos materiais necessários para a implantação do projeto.

Serão de livre escolha os métodos executivos empregados no desenvolvimento dos serviços, estando sujeitos, todavia, às determinações da fiscalização sempre que julgar necessário salva guardar a qualidade, os prazos e as condições de segurança em todos os serviços prestados.

A execução dos serviços obedecerá rigorosamente os projetos, instruções e prazos a serem fornecidos, bem como as demais disposições de Contrato e da presente Especificação Técnica.

Fica a cargo da contrata solicitar junto aos órgãos competentes, autorizações e acompanhamentos que se fizerem necessário à execução do serviço.

Sempre que houver necessidade, poderá ser determinada pela fiscalização a instalação de placas cobertas por material não transparente. A remoção dessas coberturas será realizada pelas equipes de implantação da sinalização no momento da deflagração do projeto, sem que isto represente qualquer acréscimo no valor dos serviços executados.

Os padrões de sinalização são estabelecidos pelo Manual Brasileiro de Sinalização de Trânsito do CONTRAN (Conselho Nacional de Trânsito) – Volume III em consonância com CTB (Código de Trânsito Brasileiro) e Resolução do CONTRAN nº. 160/04, e manuais DER/SP (Departamento de Estrada de Rodagem)

Suportes

Suporte para Placas de sinalização viária

Especificações gerais

Os suportes propostos nesse projeto baseiam-se em tecnologia consagrada e empregada em regiões metropolitanas e possuem similaridade de especificações técnicas e de codificação de suportes da CET/SP e DERSA.

É responsabilidade da fornecedora contratada verificar a compatibilidade entre o suporte proposto e a placa projetada, com análise e responsabilidade técnica exclusiva da fornecedora contratada, com emissão de ART correspondente.

No caso de utilização de braços projetados em postes de energia elétrica, se faz imprescindível à verificação da capacidade de carga destes e que se proceda à realização dos cálculos estruturais necessários, pela fornecedora contratada.

Suporte P51

Coluna Simples em tubo de aço galvanizado

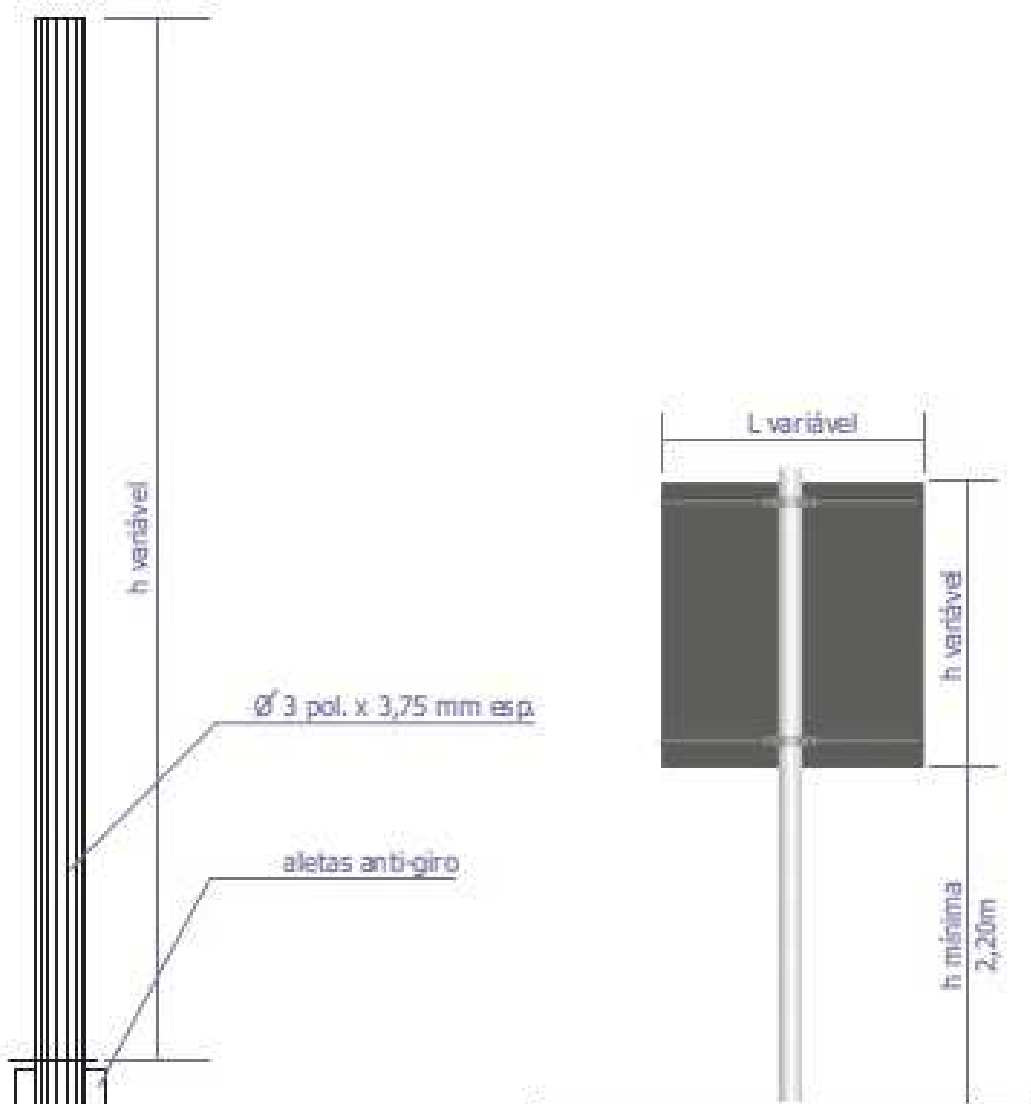

Nota:

- Representação esquemática de suporte.
- Cada modelo de suporte e suas fundações deverão ser avaliados, calculados, executados e implantados com responsabilidade técnica da fornecedora contratada, com emissão de ART correspondente ao serviço executado.

Especificações

Suporte tipo coluna simples para a sinalização viária em tubo de aço galvanizado.

A coluna deverá ser confeccionada em Aço SAE1010/20, galvanizado a fogo, com tolerâncias gerais de 2% em conformação cilíndrica de peça única, sem soldas transversais em quaisquer partes do corpo.

Altura de coluna variável de acordo com a dimensão da placa a ser instalada e obstáculos na área de implantação.

O diâmetro das seções cilíndricas deverá ser de 3 polegadas e acrescidas de aletas antigiro.

A fixação das esquadrias de placas e painéis à coluna deverá ser feita através de conjuntos de abraçadeiras parafusadas.

O suporte deverá ser totalmente galvanizado a fogo, interna e externamente, conforme NBR6323, 7399 e 7400.

Suporte P53

Coluna Dupla em tubo de Aço Galvanizado

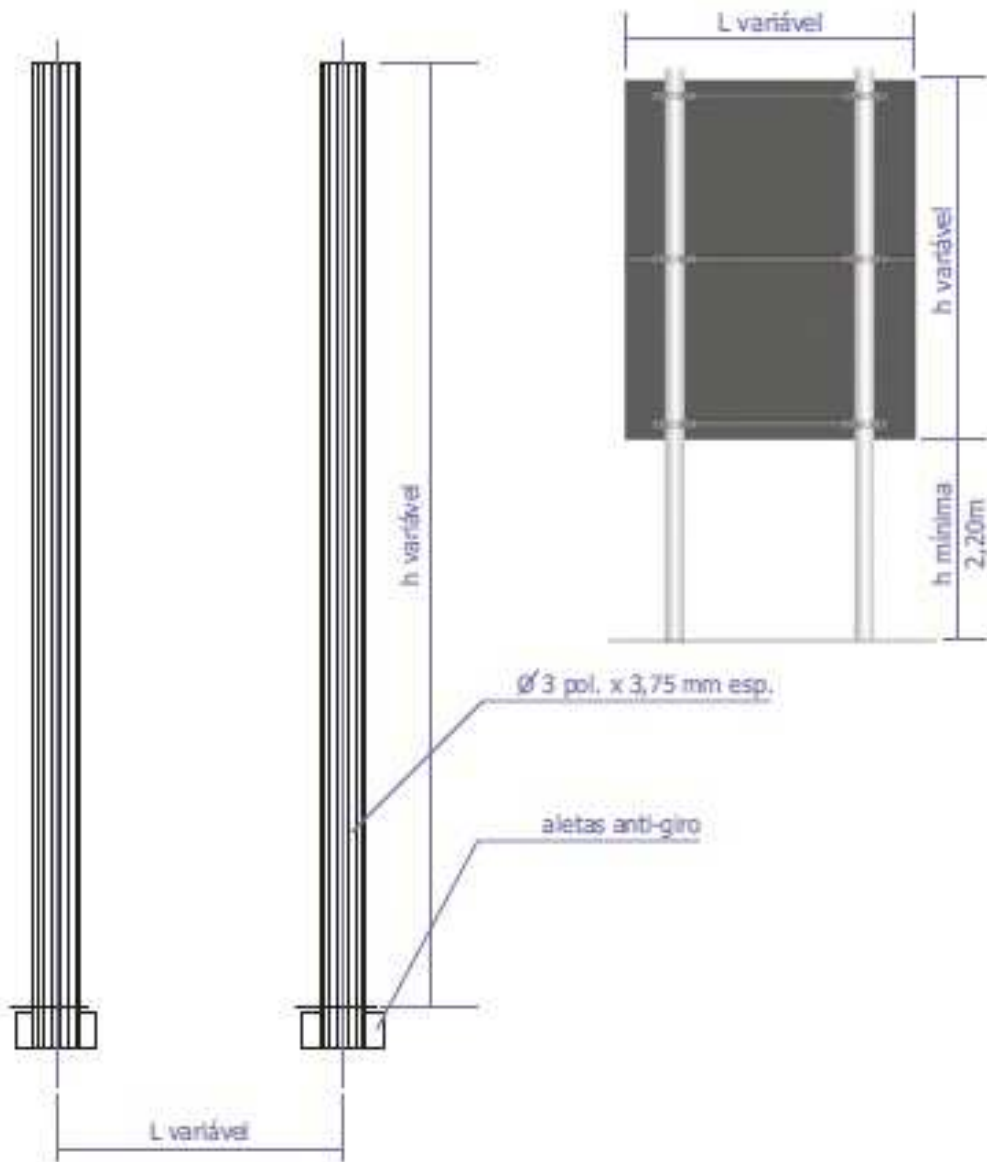

Nota:

- Representação esquemática de suporte.
- Cada modelo de suporte e suas fundações deverão ser avaliados, calculados, executados e implantados com responsabilidade técnica da fornecedora contratada, com emissão de ART correspondente ao serviço executado.

Especificações

Suporte tipo coluna dupla para a sinalização viária em tubo de aço galvanizado.

As colunas deverão ser confeccionadas em Aço SAE1010/20, galvanizado a fogo, com tolerâncias gerais de 2% em conformação cilíndrica de peça única, sem soldas transversais em quaisquer partes do corpo.

Altura de coluna variável de acordo com a dimensão da placa a ser instalada e obstáculos na área de implantação.

O diâmetro das seções cilíndricas deverá ser de 3 polegadas e acrescidas de aletas antigiro.

A fixação das esquadrias de placas e painéis à coluna deverá ser feita através de conjuntos de abraçadeiras parafusadas.

O suporte deverá ser totalmente galvanizado a fogo, interna e externamente, conforme NBR6323, 7399 e 7400.

Braço Projetado P55

Braço Projetado em tubo de Aço Galvanizado

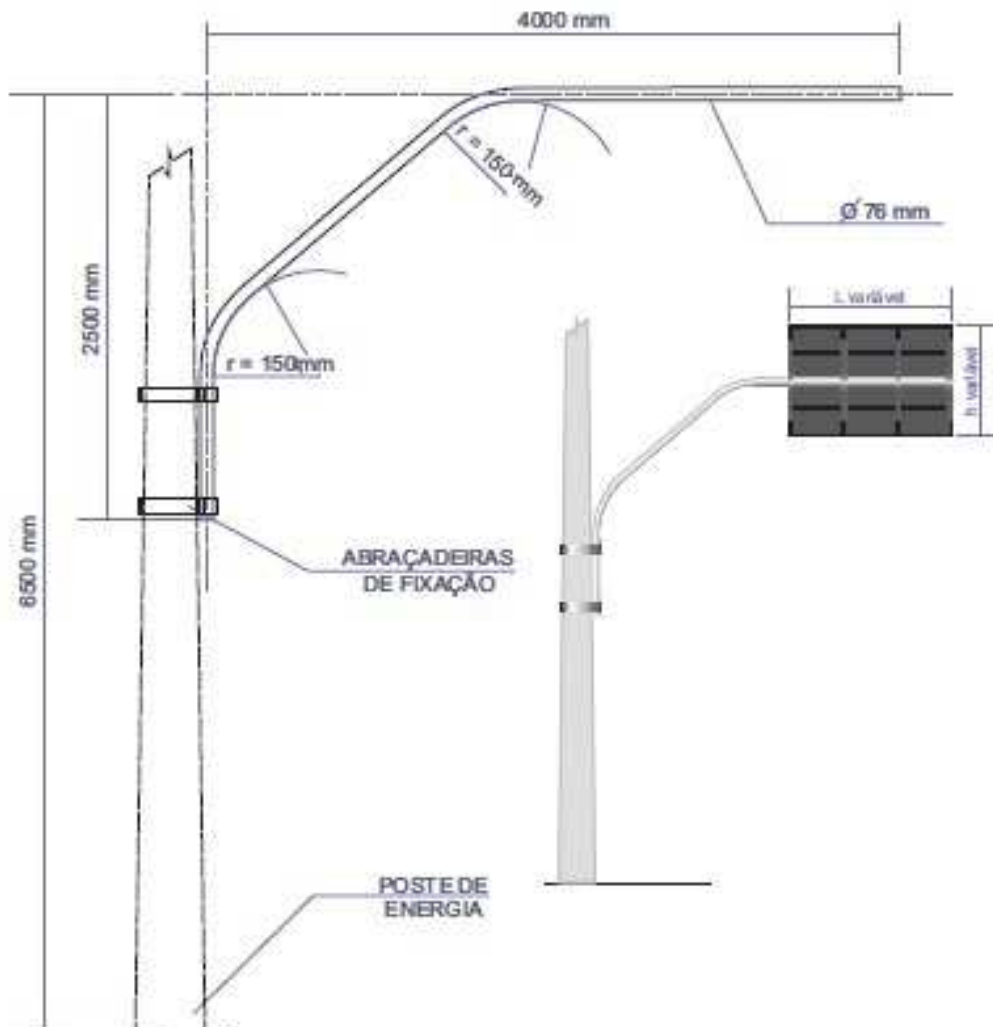

Nota:

- Representação esquemática de suporte.
- Cada modelo de suporte e suas fundações deverão ser avaliados, calculados, executados e implantados com responsabilidade técnica da fornecedora contratada, com emissão de ART correspondente ao serviço executado.
- Deverão ser avaliadas, estrutura, fundações e capacidade de carga do poste de energia elétrica, que funcionará com suporte do braço a ser instalado.

Especificações

Braço projetado para implantação acoplada a poste de energia elétrica, com projeção de 4000 mm, confeccionado em Aço SAE 1010/20, galvanizado a fogo, com tolerâncias gerais de 2%, de seção cilíndrica com 76 mm de diâmetro e comprimento de 4000 mm deverá ser fabricado em chapa de aço SAE 1010/1020, em uma única peça curvada em gabarito, sem soldas transversais.

Esse braço, com 2 raios de curvatura de 150 mm deverá possuir uma parte reta de 3000 mm, para fixação da placa de sinalização, devendo ser fixado ao poste existente de energia elétrica por meio de um conjunto de no mínimo 2 abraçadeiras unidas por conjuntos de parafusos/porcas, dimensionadas de acordo com as dimensões e conformações da seção do poste de apoio.

O suporte deverá ser totalmente galvanizado a fogo, interna e externamente, conforme NBR6323, 7399 e 7400.

Coluna + Braço Projetado P57

Coluna e Braço Projetado em tubo de Aço Galvanizado

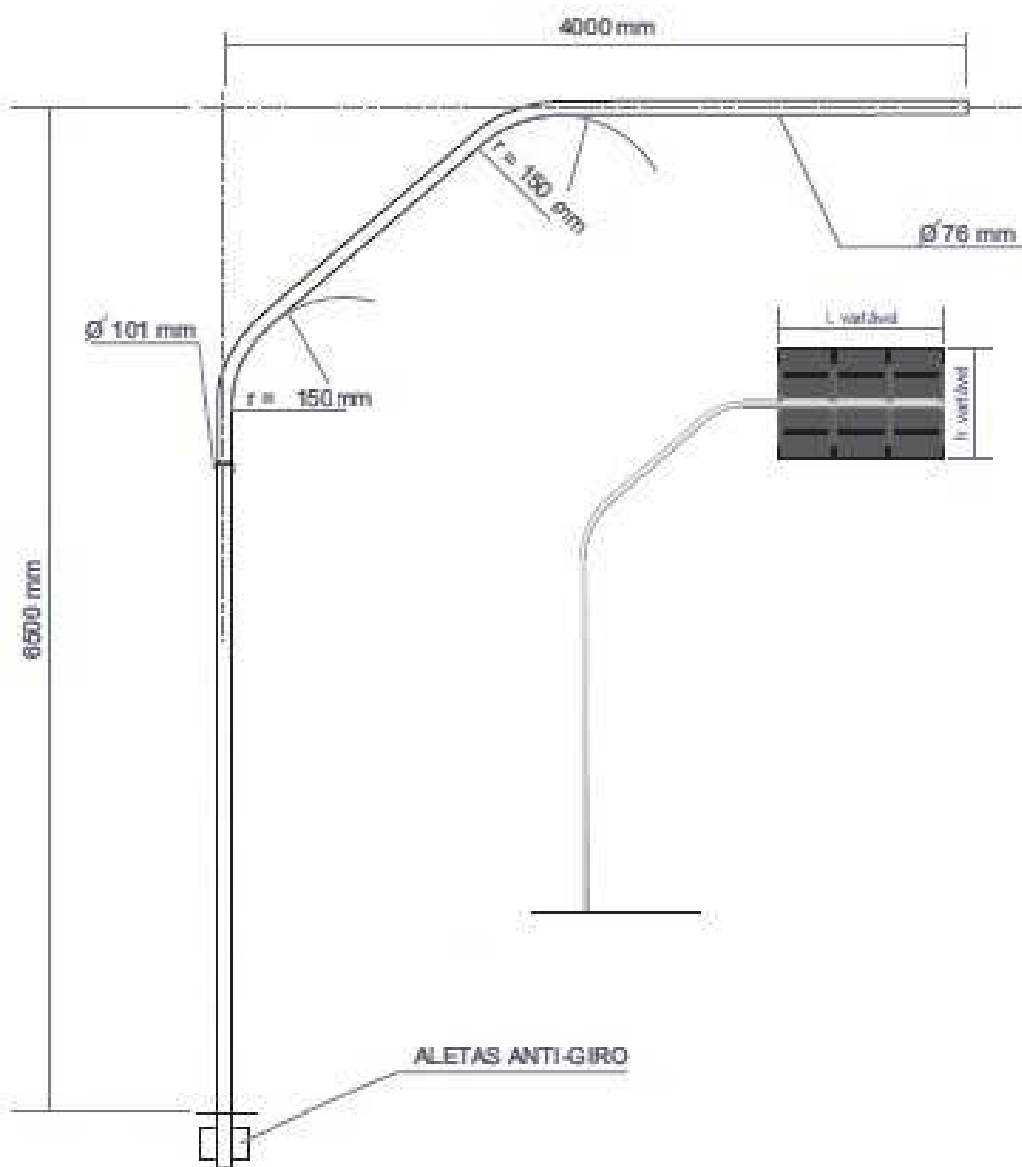

Nota:

- Representação esquemática de suporte.
- Cada modelo de suporte e suas fundações deverão ser avaliados, calculados, executados e implantados com responsabilidade técnica da fornecedora contratada, com emissão de ART correspondente ao serviço executado.

Especificações

Suporte tipo coluna com braço projetado para a sinalização viária em tubo de aço galvanizado.

Altura livre do solo de 6500 mm e projeção de 4000 mm, com base de fixação, devendo ser desmontável e composta de uma coluna e um braço projetado.

A coluna deverá ser confeccionada em Aço SAE1010/20, galvanizado a fogo, com tolerâncias gerais de 2% em conformação octogonal em peça única, com comprimento de 6100 mm, com solda longitudinal e sem soldas transversais.

O diâmetro deverá ser de 101 mm e acrescida de aletas antigiro.

Essa coluna deverá possuir um dispositivo para fixação do braço projetado no topo.

O braço projetado, de seção cilíndrica com 76 mm de diâmetro e comprimento de 4000 m deverá ser fabricado em chapa de aço SAE 1010/1020, em uma única peça curvada em gabarito, sem soldas transversais, com 2 raios de curvatura de 150 mm deverá possuir uma parte reta de 3000 mm, para fixação da placa de sinalização, devendo ser fixado à coluna por meio de quatro parafusos.

O suporte deverá ser totalmente galvanizado a fogo, interna e externamente, conforme NBR6323, 7399 e 7400.

Suporte P53m

Coluna Dupla em madeira

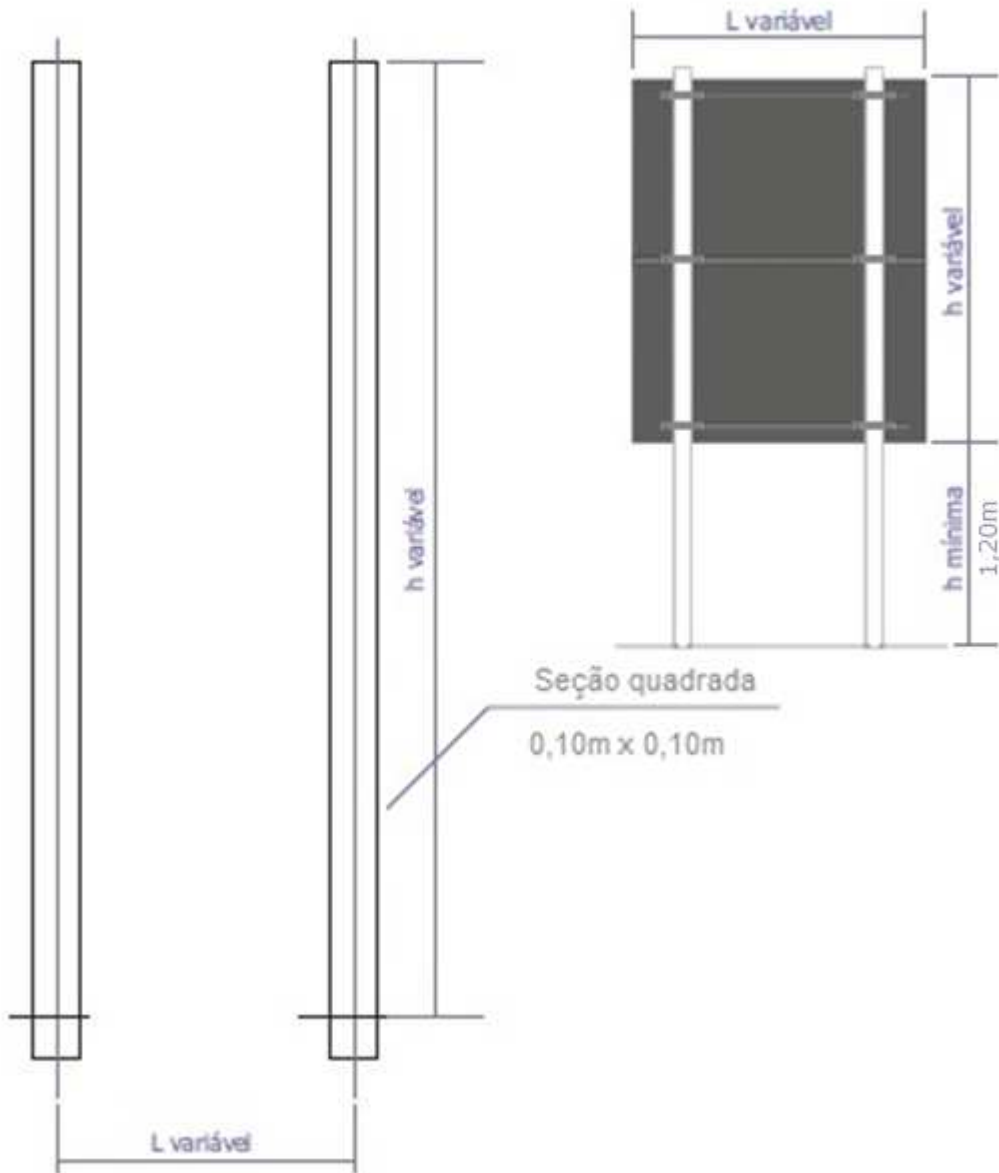

Nota:

- Representação esquemática de suporte.
- Cada modelo de suporte e suas fundações deverão ser avaliados, calculados, executados e implantados com responsabilidade técnica da fornecedora contratada, com emissão de ART correspondente ao serviço executado.

Especificações

Os suportes devem ser confeccionados com madeira de eucalipto, serrada, aparelhada e devidamente tratada com material protetor hidrossolúvel em autoclave sob vácuo e alta pressão, de acordo com o disposto na lei nº 4797 de 20/10/1965 e no decreto nº 58.016 de 18/03/1966, de forma a poder receber pintura de cor preta.

Devem apresentar índice de retenção e penetração de 6,5 kg do material protetor por m³ de madeira, conforme NBR 6232.

As peças devem ter seção quadrada de 0,10 m x 0,10 m com os cantos biselados ou chanfrados na largura de 0,01 m longitudinalmente e com uma das extremidades terminada em duplo bisel.

O sistema de fixação constituído de parafusos arruelas, porcas e outros elementos metálicos devem ser de aço carbono SAE 1008/1020, limpas, isentas de óleo, graxa, sais ou ferrugem.

Os postes de madeira devem ser pintados com duas demãos, com tinta à base de borracha clorada ou esmalte sintético na cor branca.

O sistema de fixação, parafusos, arruelas, porcas e outros elementos metálicos devem ser galvanizados interna e externamente, com deposição de zinco mínima de 350 g/m², na espessura mínima de 50 micra, conforme NBR7397(2);

O fornecedor ou fabricante dos suportes de madeira deve ser responsável pela realização dos ensaios e testes que comprovem o cumprimento das premissas da especificação técnica do DER/SP - ET-DE-L00/005A.

Os materiais empregados nos suportes de madeira devem ser analisados e terem sua qualidade comprovada em laboratório credenciado.

As dimensões dos suportes devem atender, rigorosamente, às dimensões previstas no projeto.

No recebimento técnico do material e as condições mínimas que devem ser observadas são: madeiras isentas de nós, não devem apresentar rachaduras

nas extremidades, o abaulamento não deve ultrapassar 1 cm de flecha, a arqueadura não deve exceder 2 cm de flecha, deve apresentar pintura uniforme.

Todo o material fornecido deve ser submetido previamente à inspeção visual pelo DER/SP, cabendo a este o direito de recusar os que apresentem algum defeito ou que não estejam de acordo com o especificado.

Deve ser apresentada garantia mínima de durabilidade de 10 anos para os suportes de madeira fornecidos.

Placas

PLACAS DE ALUMÍNIO PARA SINALIZAÇÃO VIÁRIA VERTICAL

Especificações gerais

As chapas destinadas à confecção das placas de alumínio devem ser planas, do tipo AA5052, têmpera H-38, com espessura de 2,00 mm.

Deve atender as normas da Associação Brasileira de Normas Técnicas, ABNT, e da American Society for Testing and Materials, ASTM, apresentadas a seguir:

- ASTM B 209M(1), specification aluminium and aluminium alloy sheet and plate;
- ASTM E 34(2), chemical analysis of aluminium and aluminium base alloys;
- NBR ISSO 6892(3), materiais metálicos, ensaio de tração à temperatura ambiente.

As chapas de alumínio depois de cortadas nas dimensões finais e furadas, devem ter suas bordas lixadas antes do processo de tratamento composto por:

- retirada de graxa, decapagem, em ambas as faces;
- aplicação no verso de demão de wash primer, à base de cromato de zinco com solvente especial para a galvanização de secagem em estufa.

O acabamento final do verso pode ser feito:

- com uma demão de primer sintético e duas demãos de esmalte sintético, à base de resina alquídica ou poliéster na cor preto fosco, com secagem em estufa à temperatura de 140 °C, ou;
- com tinta a pó, à base de resina poliéster por deposição eletrostática, com polimerização em estufa a 220 °C e com espessura de película de 50 micra.

No verso da placa deve constar o nome do fabricante da placa, DER/SP e a data da fabricação com mês e ano.

As placas de alumínio devem ser estruturalmente reforçadas com perfil de alumínio L-421 e liga 6063 T-5, com dimensões 33 mm x 40 mm.

As cantoneiras e barras devem ser confeccionadas na liga 6063-T6.

Placas maiores que 3,0 m² devem ser moduladas com o mesmo perfil L 421.

Os módulos devem possuir máximo 2,00 m por 1,0 m, e os parafusos de ligação entre módulos devem ser de aço inoxidável.

Os suportes para a sustentação das placas devem atender às especificações técnicas:

- ET-DE-L00/005 – Suportes de madeira para placas de sinalização vertical;

- ET-DEL00/006 - Suporte de perfil metálico galvanizado para sinalização vertical.

As mensagens contidas nas placas devem ser elaboradas em películas adesivas que atendam à especificação técnica ET-DE-L00/004, Películas Adesivas para Placas de Sinalização Viária.

No caso das placas estruturadas, a fixação das placas de alumínio à sua estrutura, módulos, deve ser efetuada através da utilização de fita adesiva dupla face com largura mínima de 25 mm, atendendo às normas da ASTM discriminadas a seguir:

- ASTM 1637 - Ensaio de Aderência;

- ASTM TM 1720 - Ensaio de Resistência ao Cisalhamento;

- ASTM TM 1724 - Ensaio de Resistência ao Cisalhamento Dinâmico.

As placas de alumínio devem manter-se nos padrões fixados na especificação técnica do DER/SP - ET-DE-L00/002A, por um período mínimo de sete anos.

As placas devem ser estruturalmente dimensionadas para resistirem a ventos de até 35 m/s sem sofrerem quaisquer tipos de danos.

Placa – 01 (Suporte P53m)

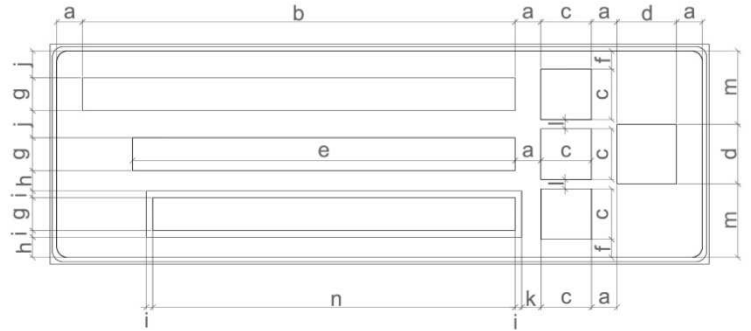

Status: Implementar
Dimensões: 3.00m x 1.00m

Tabela de cotas (mm):

a	b	c	d	e	f	g	h	i	j	K	l	m	n
117	1971	230	271	1493	83	150	73	50	122	67	42	334,5	1448



Fundo: Marrom
Tarja: Branco
Letra: Branco
Borda: Marrom
Pictograma: 230mm x 230mm

Seta: Tipo S2/ Cor: Branco



Fundo: Azul
Letra: Branco
Pictograma: 230mm x 230mm

Contorno (mm)

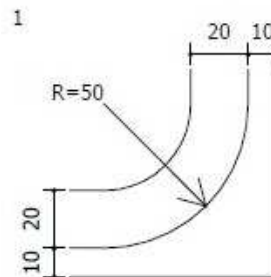

Fonte: Série E(m)

Altura (mm): 150

Cor: Branca

Largura (mm): 1971

122	99	99	78	75	102	150	122	
C	e	n	t	r	o		H	
	29	47	44	48	23	0	0	51

30	99	78	102	75	30	99	102
i	s	t	ó	r	i	c	o
	44	30	35	47	36	47	33

Fonte: Série E(m)

Altura (mm): 150

Cor: Branca

Largura (mm): 1493

122	99	75	75	99	150	30	78	
S	e	r	r	a		l	t	
	33	47	36	23	0	0	44	35

99	99	99	99
a	g	u	á
	47	60	47

Fonte: Série E(m)

Altura (mm): 150

Cor: Branca

Largura (mm): 1448

122	102	99	99	99	99	99	99	
H	o	s	p	e	d	a	g	
	38	30	47	33	33	47	47	47

99	165
e	m
	47

Placa – 02 (Suporte P53)



Status: Implementar
Dimensões: 2.55m x 1.05m

Tabela de cotas (mm):

a	b	c	d	e	f	g	h	i	j	k
92,5	1643	200	195	95,8	125	175	1725	70.8	1460	58,3

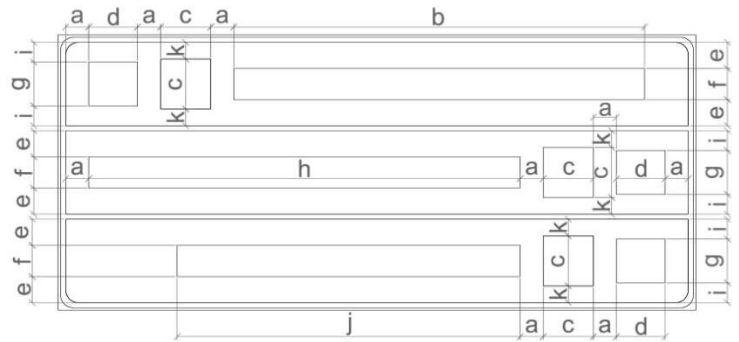

Fundo: Marrom
Tarja: Branco
Letra: Branco
Borda: Marrom
Pictograma: 200mm x 200mm

Seta: Tipo S1/ Cor: Branco



Fundo: Marrom
Tarja: Branco
Letra: Branco
Borda: Marrom
Pictograma: 200mm x 200mm

Seta: Tipo S1/ Cor: Branco



Fundo: Azul
Tarja: Branco
Letra: Branco
Borda: Azul
Pictograma: 200mm x 200mm

Seta: Tipo S1/ Cor: Branco

Contorno (mm)

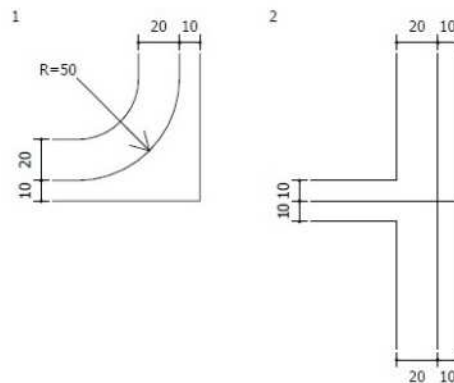

Fonte: Série E(m)

Altura (mm): 125

Cor: Branca

Largura (mm): 1643

101	83	83	65	63	85	125	101	
C	e	n	t	r	o		H	
	24	39	36	40	19	0	0	43

25	83	65	85	63	25	83	85
i	s	t	ó	r	i	c	o
	36	25	29	39	30	39	28

Fonte: Série E(m)

Altura (mm): 125

Cor: Branca

Largura (mm): 1725

93	83	63	25	101	83	83	65	
T	u	r	.	G	a	s	t	
	30	50	10	18	26	36	25	40

63	85	83	85	138	25	83	85
r	o	n	ô	m	i	c	o
	19	39	39	39	50	39	28

Fonte: Série E(m)

Altura (mm): 125

Cor: Branca

Largura (mm): 1460

101	83	138	83	85	125	83	83	
C	a	m	p	o		d	e	
	24	50	50	28	0	0	39	0

125	101	85	25	53
	G	o	l	f
	0	26	39	38

Placa – 03 (Suporte P55)

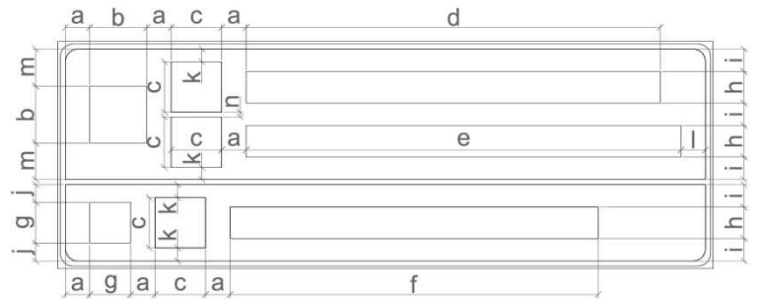

Status: Implementar
Dimensões: 2,60m x 0,90m

Tabela de cotas (mm):

a	b	c	d	e	f	g	h	i	j	k	l	m	n
95	226	200	1643	1725	1460	162	125	89	70,5	51,5	104	145,5	14



Fundo: Marrom
Tarja: Branco
Letra: Branco
Borda: Marrom
Pictograma: 200mm x 200mm

Seta: Tipo S2/ Cor: Branco



Fundo: Azul
Tarja: Branco
Letra: Branco
Borda: Azul
Pictograma: 200mm x 200mm

Seta: Tipo S1/ Cor: Branca

Contorno (mm)

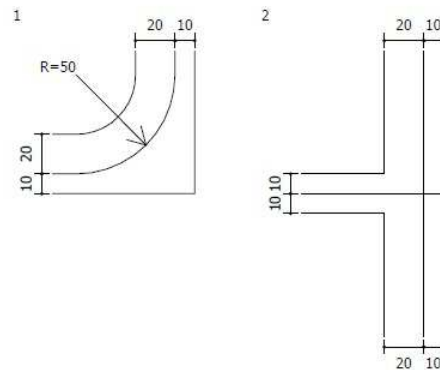

Fonte: Série E(m)

Altura (mm): 125

Cor: Branca

Largura (mm): 1643

101	83	83	65	63	85	125	101	
C	e	n	t	r	o		H	
	24	39	36	40	19	0	0	43

25	83	65	85	63	25	83	85
i	s	t	ó	r	i	c	o
	36	25	29	39	30	39	28

Fonte: Série E(m)

Altura (mm): 125

Cor: Branca

Largura (mm): 1725

93	83	63	25	101	83	83	65	
T	u	r	.	G	a	s	t	
	30	50	10	18	26	36	25	40

63	85	83	85	138	25	83	85
r	o	n	ô	m	i	c	o
	19	39	39	39	50	39	28

Fonte: Série E(m)

Altura (mm): 125

Cor: Branca

Largura (mm): 1460

101	83	138	83	85	125	83	83	
C	a	m	p	o		d	e	
	24	50	50	28	0	0	39	0

125	101	85	25	53
	G	o	l	f
	0	26	39	38

Placa – 04 (Suporte P55)

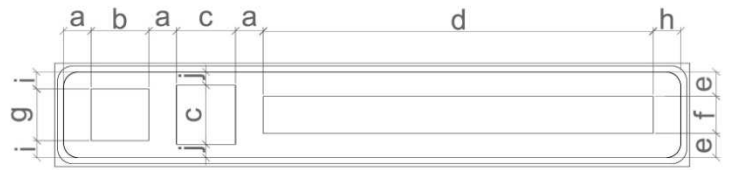

Status: Implementar
 Dimensões: 2,15m x 0,35m

Tabela de cotas (mm):

a	b	c	d	e	f	g	h	i	j
94	195	200	1320	82,5	125	175	93	57,5	45



Fundo: Marrom
 Tarja: Branco
 Letra: Branco
 Borda: Marrom
 Pictograma: 200mm x 200mm

Seta: Tipo S1/ Cor: Branco

Contorno (mm)

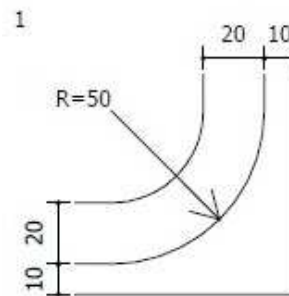

Fonte: Série E(m)

Altura (mm): 125

Cor: Branca

Largura (mm): 1320

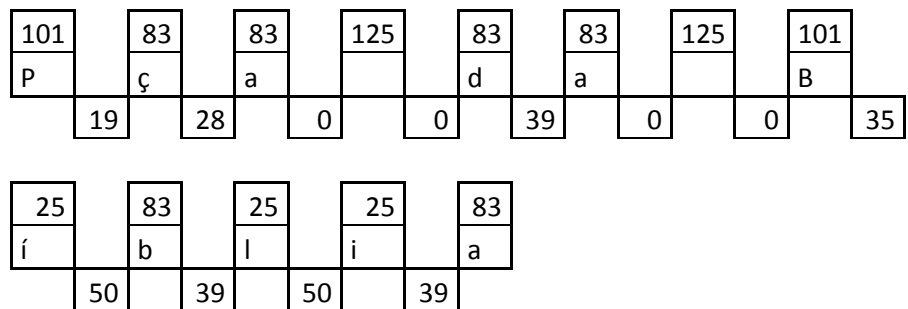

Placa – 05 (Suporte P57)

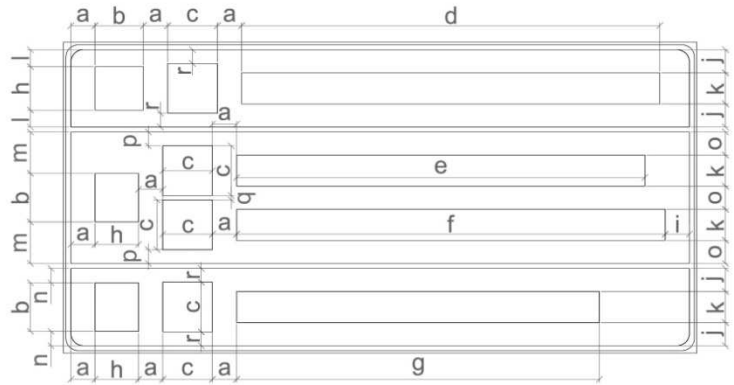

Status: Implementar
Dimensões: 2,55m x 1,25m

Tabela de cotas (mm):

a	b	c	d	e	f	g	h	i	j	k	l	m	n	o	p	q	r
98	195	200	1683	1643	1725	1460	175	96	92	125	67	168,5	57	94	56,5	19	54,5



Fundo: Marrom
Tarja: Branco
Letra: Branco
Borda: Marrom
Pictograma: 200mm x 200mm

Seta: Tipo S1/ Cor: Branco



Fundo: Marrom
Tarja: Branco
Letra: Branco
Borda: Marrom
Pictograma: 200mm x 200mm

Seta: Tipo S2/ Cor: Branco



Fundo: Azul
Tarja: Branco
Letra: Branco
Borda: Azul
Pictograma: 200mm x 200mm

Seta: Tipo S1/ Cor Branco

Contorno (mm)

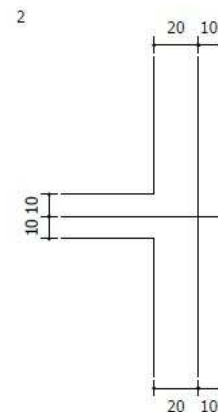
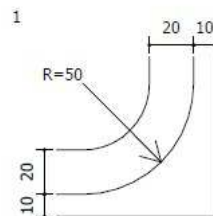

Fonte: Série E(m)

Altura (mm): 125

Cor: Branca

Largura (mm): 1683

93	83	65	83	83	83	85	125
E	s	t	a	ç	ã	o	
	20	25	29	39	28	39	0

101	83	25	65	83	63	83	25
C	u	l	t	u	r	a	l
	35	50	36	40	50	19	50

Fonte: Série E(m)

Altura (mm): 125

Cor: Branca

Largura (mm): 1643

101	83	83	65	63	85	125	101
C	e	n	t	r	o		H
	24	39	36	40	19	0	0

25	83	65	85	63	25	83	85
i	s	t	ó	r	i	c	o
	36	25	29	39	30	39	28

Fonte: Série E(m)

Altura (mm): 125

Cor: Branca

Largura (mm): 1725

93	83	63	25	101	83	83	65
T	u	r	.	G	a	s	t
	30	50	10	18	26	36	25

63	85	83	85	138	25	83	85
r	o	n	ô	m	i	c	o
	19	39	39	39	50	39	28

Fonte: Série E(m)

Altura (mm): 125

Cor: Branca

Largura (mm): 1460

101	83	138	83	85	125	83	83
C	a	m	p	o		d	e
	24	50	50	28	0	0	39

125	101	85	25	53
	G	o	l	f
	0	26	39	38

Placa – 06 (Suporte P55)

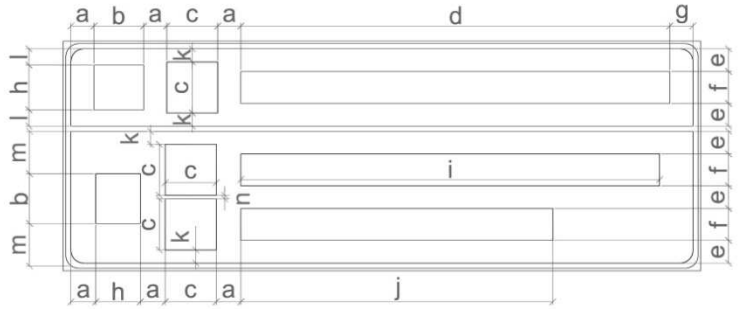

Status: Implementar
Dimensões: 2,50m x 0,90m

Tabela de cotas (mm):

a	b	c	d	e	f	g	h	i	j	k	l	m	n
91	195	200	1683	89	125	89	175	1643	1244	51,5	64	161	14



Fundo: Marrom
Tarja: Branco
Letra: Branco
Borda: Marrom
Pictograma: 200mm x 200mm

Seta: Tipo S1/ Cor: Branco



Fundo: Marrom
Tarja: Branco
Letra: Branco
Borda: Marrom
Pictograma: 200mm x 200mm

Seta: Tipo S2/ Cor: Branco

Contorno (mm)

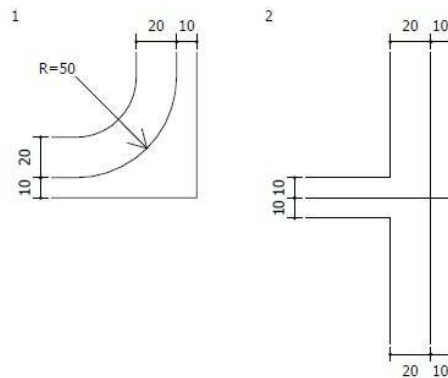

Fonte: Série E(m)

Altura (mm): 125

Cor: Branca

Largura (mm): 1683

93	83	65	83	83	83	85	125	
E	s	t	a	ç	ã	o		
	20	25	29	39	28	39	0	0

101	83	25	65	83	63	83	25
C	u	l	t	u	r	a	l
	35	50	36	40	50	19	50

Fonte: Série E(m)

Altura (mm): 125

Cor: Branca

Largura (mm): 1643

101	83	83	65	63	85	125	101
C	e	n	t	r	o		H
	24	39	36	40	19	0	0
							43

25	83	65	85	63	25	83	85
i	s	t	ó	r	i	c	o
	36	25	29	39	30	39	28

Fonte: Série E(m)

Altura (mm): 125

Cor: Branca

Largura (mm): 1244

101	83	63	63	83	125	25	65
S	e	r	r	a		l	t
	28	39	30	19	0	0	36
							29

83	83	83	83
a	g	u	á
	39	50	39

Placa – 07 (Braço Semafórico Existente)

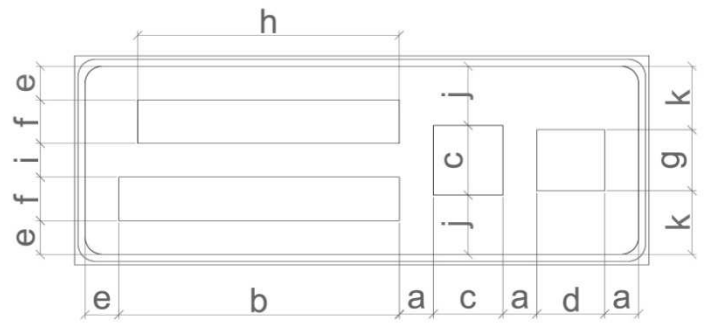

Status: Implementar
Dimensões: 1,65m x 0,60m

Tabela de cotas (mm):

a	b	c	d	e	f	g	h	i	j	k
97	806	200	195	98	125	175	751	94	170	182,5



Fundo: Marrom
Tarja: Branco
Letra: Branco
Borda: Marrom
Pictograma: 200mm x 200mm

Seta: Tipo S3/ Cor: Branco

Contorno (mm)

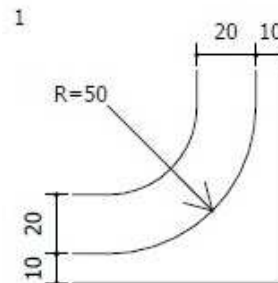

Fonte: Série E(m)

Altura (mm): 125

Cor: Branca

Largura (mm): 751

93	83	65	83	83	83	85
E	s	t	a	ç	ã	o
	20	25	29	39	28	39

Fonte: Série E(m)

Altura (mm): 125

Cor: Branca

Largura (mm): 806

101	83	25	65	83	63	83	25
C	u	l	t	u	r	a	l
	35	50	36	40	50	19	50

Placa – 08 (Suporte P55)



Status: Implementar
Dimensões: 2,55m x 1,00m

Tabela de cotas (mm):

a	b	c	d	e	f	g	h	i	j	k	l	m	n	o
1176	93	200	1725	195	1578	1171	88	125	175	50,5	13	381	91	382,5

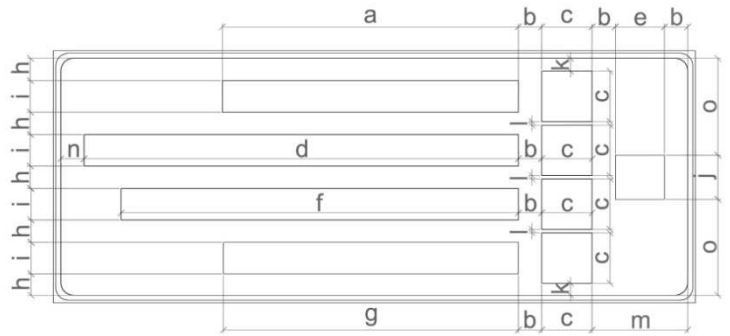

Fundo: Marrom
Tarja: Branco
Letra: Branco
Borda: Marrom
Pictograma: 200mm x 200mm
Seta: Tipo S3/ Cor: Branco

Contorno (mm)

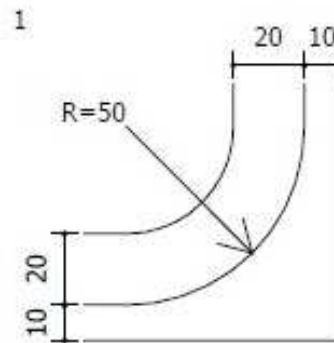

Fonte: Série E(m)

Altura (mm): 125

Cor: Branca

Largura (mm): 1176

93	83	63	25	101	83	25	65	
T	u	r	.	C	u	l	t	
	30	50	10	18	35	50	36	40

83	63	83	25
u	r	a	l
	50	19	50

Fonte: Série E(m)

Altura (mm): 125

Cor: Branca

Largura (mm): 1725

93	83	63	25	101	83	83	65	
T	u	r	.	G	a	s	t	
	30	50	10	18	26	36	25	40

63	85	83	85	138	25	83	85
r	o	n	ô	m	i	c	o
	19	39	39	39	50	39	28

Fonte: Série E(m)

Altura (mm): 125

Cor: Branca

Largura (mm): 1578

101	25	125	83	83	125	116	83	
C	.		d	e		M	e	
	15	0	0	39	0	0	31	28

83	25	65	83	83	83	85
d	i	t	a	ç	ã	o
	50	36	29	39	28	39

Fonte: Série E(m)

Altura (mm): 125

Cor: Branca

Largura (mm): 1171

101	83	83	100	25	83	83	83	
G	u	a	x	i	n	d	u	
	38	39	39	39	50	39	50	36

96	83
v	a
	25

Placa – 09 (Suporte P55)

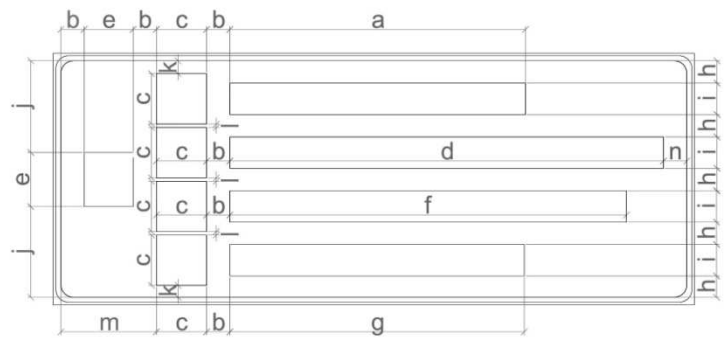

Status: Implementar
 Dimensões: 2,60m x 1,00 m

Tabela de cotas (mm):

a	b	c	d	e	f	g	h	i	j	k	l	m	n
1176	98	200	1725	226	1578	1171	88	125	357	50,5	13	422	95



Fundo: Marrom
 Tarja: Branco
 Letra: Branco
 Borda: Marrom
 Pictograma: 200mm x 200mm
 Seta: Tipo S2/ Cor: Branco

Contorno (mm)

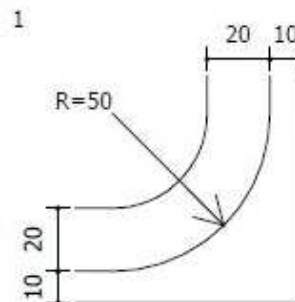

Fonte: Série E(m)

Altura (mm): 125

Cor: Branca

Largura (mm): 1176

93	83	63	25	101	83	25	65	
T	u	r	.	C	u	l	t	
	30	50	10	18	35	50	36	40

83	63	83	25
u	r	a	l
	50	19	50

Fonte: Série E(m)

Altura (mm): 125

Cor: Branca

Largura (mm): 1725

93	83	63	25	101	83	83	65	
T	u	r	.	G	a	s	t	
	30	50	10	18	26	36	25	40

63	85	83	85	138	25	83	85
r	o	n	ô	m	i	c	o
	19	39	39	39	50	39	28

Fonte: Série E(m)

Altura (mm): 125

Cor: Branca

Largura (mm): 1578

101	25	125	83	83	125	116	83	
C	.		d	e		M	e	
	15	0	0	39	0	0	31	28

83	25	65	83	83	83	85
d	i	t	a	ç	ã	o
	50	36	29	39	28	39

Fonte: Série E(m)

Altura (mm): 125

Cor: Branca

Largura (mm): 1171

101	83	83	100	25	83	83	83	
G	u	a	x	i	n	d	u	
	38	39	39	39	50	39	50	36

96	83
v	a
	25

Placa – 10 (Suporte P53m)

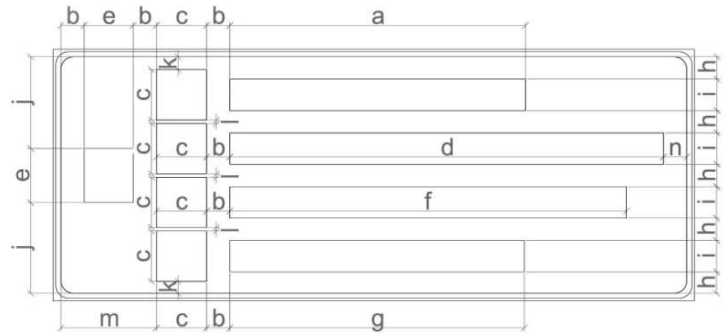

Status: Implementar
Dimensões: 3,10m x 1,25m

Tabela de cotas (mm):

a	b	c	d	e	f	g	h	i	j	k	l	m	n
1412	110	230	2070	271	1893	1406	112	150	444,5	72	32	491	109



Fundo: Marrom
Tarja: Branco
Letra: Branco
Borda: Marrom
Pictograma: 230mm x 230mm

Seta: Tipo S2/ Cor: Branco

Contorno (mm)

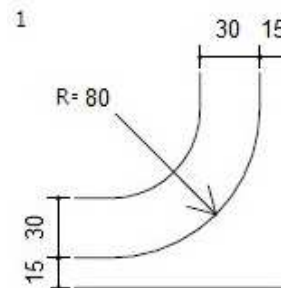

Fonte: Série E(m)
 Altura (mm): 150
 Cor: Branca
 Largura (mm): 1412

111	99	75	30	122	99	30	78
T	u	r	.	C	u	l	t
	36	60	12	21	42	60	44
99	75	99	30				
u	r	a	l				
	60	23	60				

Fonte: Série E(m)
 Altura (mm): 150
 Cor: Branca
 Largura (mm): 2070

111	99	75	30	122	99	99	78
T	u	r	.	G	a	s	t
	36	60	12	21	32	44	30
							48
75	102	99	102	165	30	99	102
r	o	n	ô	m	i	c	o
	23	47	47	47	60	47	33

Fonte: Série E(m)
 Altura (mm): 150
 Cor: Branca
 Largura (mm): 1893

122	30	150	99	99	150	140	99
C	.		d	e		M	e
	18	0	0	47	0	0	38
							33
99	30	78	99	99	99	102	
d	i	t	a	ç	ã	o	
	60	44	35	47	33	47	

Fonte: Série E(m)
 Altura (mm): 150
 Cor: Branca
 Largura (mm): 1406

122	99	99	120	30	99	99	99
G	u	a	x	i	n	d	u
	45	47	47	47	60	47	60
							44
116	99						
v	a						
	30						

Placa – 11, 13 e 14 (Suporte P55)

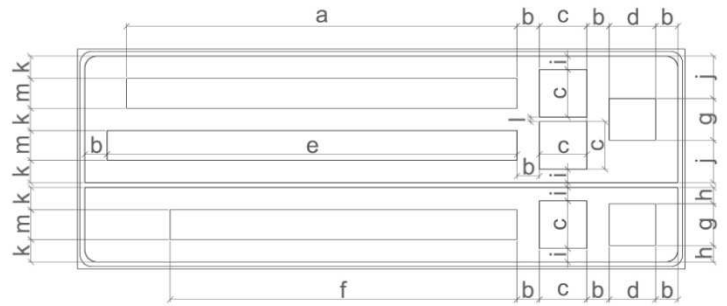

Status: Implementar
Dimensões: 2,50m x 0,90m

Tabela de cotas (mm):

a	b	c	d	e	f	g	h	i	j	k	l	m
1643	80	200	195	1725	1460	175	64	51,5	171	89	14	125



Fundo: Marrom
Tarja: Branco
Letra: Branco
Borda: Marrom
Pictograma: 200mm x 200mm

Seta: Tipo S3 / Cor: Branco



Fundo: Azul
Tarja: Branco
Letra: Branco
Borda: Azul
Pictograma: 200mm x 200mm

Seta: Tipo S1 / Cor: Branco

Contorno (mm)

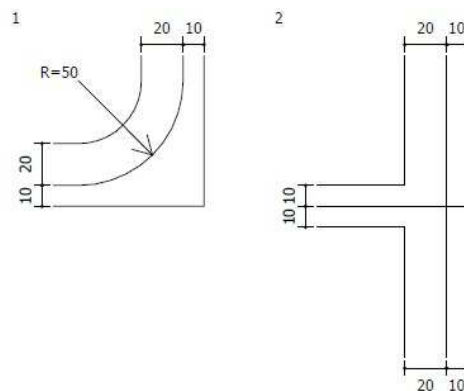

Fonte: Série E(m)

Altura (mm): 125

Cor: Branca

Largura (mm): 1643

101	83	83	65	63	85	125	101	
C	e	n	t	r	o		H	
	24	39	36	40	19	0	0	43

25	83	65	85	63	25	83	85
i	s	t	ó	r	i	c	o
	36	25	29	39	30	39	28

Fonte: Série E(m)

Altura (mm): 125

Cor: Branca

Largura (mm): 1725

93	83	63	25	101	83	83	65	
T	u	r	.	G	a	s	t	
	30	50	10	18	26	36	25	40

63	85	83	85	138	25	83	85
r	o	n	ô	m	i	c	o
	19	39	39	39	50	39	28

Fonte: Série E(m)

Altura (mm): 125

Cor: Branca

Largura (mm): 1460

101	83	138	83	85	125	83	83	
C	a	m	p	o		d	e	
	24	50	50	28	0	0	39	0

125	101	85	25	53
	G	o	l	f
	0	26	39	38

Placa – 12 (Suporte P57)



Status: Implementar
Dimensões: 2,60m x 0,90m

Tabela de cotas (mm):

a	b	c	d	e	f	g	h	i	j	k	l	m	n
1643	98	200	226	1725	1460	194	54,5	51,5	145,5	89	14	125	95

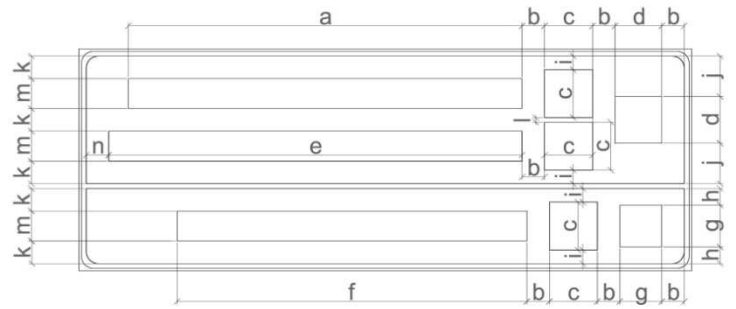

Fundo: Marrom
Tarja: Branco
Letra: Branco
Borda: Marrom
Pictograma: 200mm x 200mm

Seta: Tipo S2 / Cor: Branco



Fundo: Azul
Tarja: Branco
Letra: Branco
Borda: Azul
Pictograma: 200mm x 200mm

Seta: Tipo S1 / Cor: Branco

Contorno (mm)

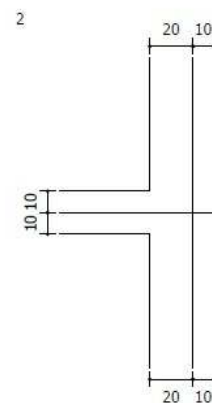
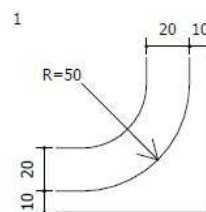

Fonte: Série E(m)

Altura (mm): 125

Cor: Branca

Largura (mm): 1643

101	83	83	65	63	85	125	101	
C	e	n	t	r	o		H	
	24	39	36	40	19	0	0	43

25	83	65	85	63	25	83	85
i	s	t	ó	r	i	c	o
	36	25	29	39	30	39	28

Fonte: Série E(m)

Altura (mm): 125

Cor: Branca

Largura (mm): 1725

93	83	63	25	101	83	83	65	
T	u	r	.	G	a	s	t	
	30	50	10	18	26	36	25	40

63	85	83	85	138	25	83	85
r	o	n	ô	m	i	c	o
	19	39	39	39	50	39	28

Fonte: Série E(m)

Altura (mm): 125

Cor: Branca

Largura (mm): 1460

101	83	138	83	85	125	83	83	
C	a	m	p	o		d	e	
	24	50	50	28	0	0	39	0

125	101	85	25	53
	G	o	l	f
	0	26	39	38

Placa – 15 (Suporte P51)



Status: Implementar
Dimensões: 0,85m x 0,75m



Tabela de cotas (mm):

a	b	c	d	e	f	g	h
305	200	77,5	100	601	104,5	645	82,5

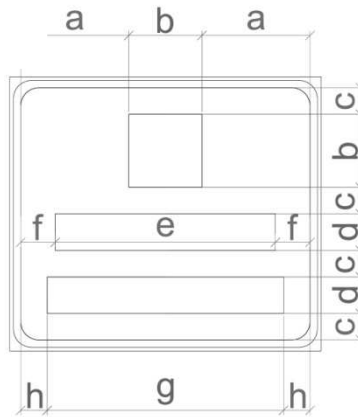

Fundo: Marrom
Tarja: Branco
Letra: Branco
Borda: Marrom
Pictograma: 200mm x 200mm

Contorno (mm)

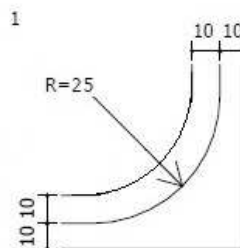

Fonte: Série E(m)

Altura (mm): 100

Cor: Branca

Largura (mm): 601

74	66	52	66	66	66	68
E	s	t	a	ç	ã	o
	16	20	23	31	22	31

Fonte: Série E(m)

Altura (mm): 100

Cor: Branca

Largura (mm): 645

81	66	20	52	66	50	66	20
C	u	l	t	u	r	a	l
	28	40	29	32	40	15	40

Placa – 16 (Suporte P57)



Status: Implementar
Dimensões: 2,70m x 1,25m



Tabela de cotas (mm):

a	b	c	d	e	f	g	h	i	j	k	l	m	n	o	p	q	r
93	195	200	1578	1896	1196	483	175	90	92	125	67	168,5	57	94	56,5	19	54,5

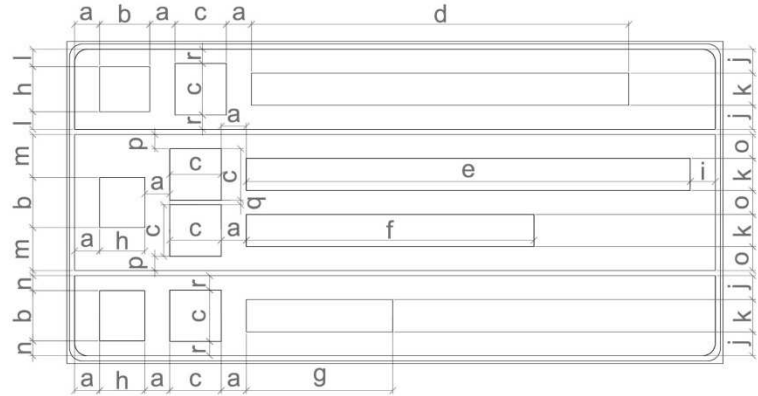

Fundo: Marrom
Tarja: Branco
Letra: Branco
Borda: Marrom
Pictograma: 200mm x 200mm

Seta: Tipo S1 / Cor: Branco

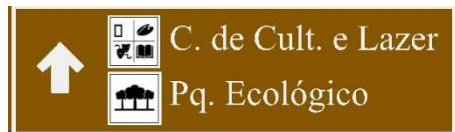

Fundo: Marrom
Tarja: Branco
Letra: Branco
Borda: Marrom
Pictograma: 200mm x 200mm

Seta: Tipo S2 / Cor: Branco



Fundo: Azul
Tarja: Branco
Letra: Branco
Borda: Azul
Pictograma: 200mm x 200mm

Seta: Tipo S1 / Cor: Branco

Contorno (mm)

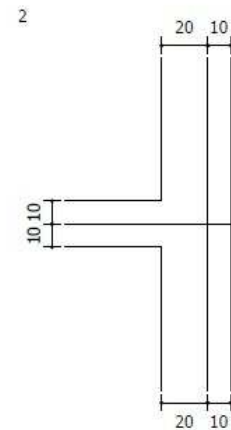
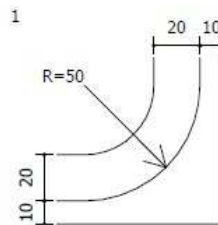

Fonte: Série E(m)

Altura (mm): 125

Cor: Branca

Largura (mm): 1578

101	25	125	83	83	125	116	83
C	.		d	e		M	e
15	0	0	39	0	0	31	28

83	25	65	83	83	83	85
d	i	t	a	ç	ã	o
50	36	29	39	28	39	

Fonte: Série E(m)

Altura (mm): 125

Cor: Branca

Largura (mm): 1896

101	25	125	83	83	125	101	83
C	.		d	e		C	u
15	0	0	39	0	0	35	50

25	65	25	125	83	125	93	83
l	t	.		e		L	a
36	20	0	0	0	0	16	40

85	83	63
z	e	r
29	39	

Fonte: Série E(m)

Altura (mm): 125

Cor: Branca

Largura (mm): 1196

101	83	25	93	83	85	25	85
P	q	.	E	c	o	l	ó
19	30	23	23	28	39	39	28

83	25	83	85
g	i	c	o
50	39	28	

Fonte: Série E(m)

Altura (mm): 125

Cor: Branca

Largura (mm): 483

101	85	65	83	25
H	o	t	e	l
31	25	29	39	

Placa – 17 (Suporte P55)

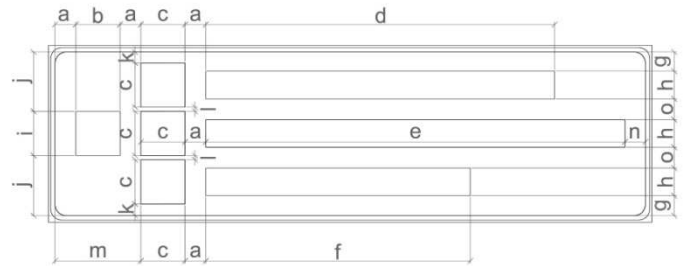

Status: Implementar
Dimensões: 2,70m x 0,80m

Tabela de cotas (mm):

a	b	c	d	e	f	g	h	i	j	k	l	m	n	o
88	195	200	1578	1896	1196	90,5	125	175	282,5	53	17	371	85	92



Fundo: Marrom
Tarja: Branco
Letra: Branco
Borda: Marrom
Pictograma: 200mm x 200mm
Seta: Tipo S3 / Cor: Branco

Contorno (mm)

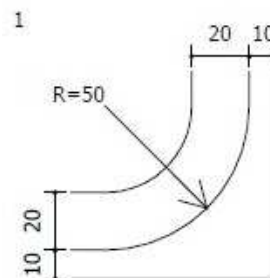

Fonte: Série E(m)

Altura (mm): 125

Cor: Branca

Largura (mm): 1578

101	25	125	83	83	125	116	83	
C	.		d	e		M	e	
	15	0	0	39	0	0	31	28
83	25	65	83	83	83	85		
d	i	t	a	ç	ã	o		
	50	36	29	39	28	39		

Fonte: Série E(m)

Altura (mm): 125

Cor: Branca

Largura (mm): 1896

101	25	125	83	83	125	101	83	
C	.		d	e		C	u	
	15	0	0	39	0	0	35	50
25	65	25	125	83	125	93	83	
l	t	.		e		L	a	
	36	20	0	0	0	0	16	40
85	83	63						
z	e	r						
	29	39						

Fonte: Série E(m)

Altura (mm): 125

Cor: Branca

Largura (mm): 1196

101	83	25	93	83	85	25	85	
P	q	.	E	c	o	l	ó	
	19	30	23	23	28	39	39	28
83	25	83	85					
g	i	c	o					
	50	39	28					

Placa – 18 (Suporte P55)



Status: Implementar
Dimensões: 2,70m x 1,15m

Tabela de cotas (mm):

a	b	c	d	e	f	g	h	i	j	k	l	m	n	o
1171	87	200	195	1896	1196	483	290	20	175	125	57,5	95	88	70

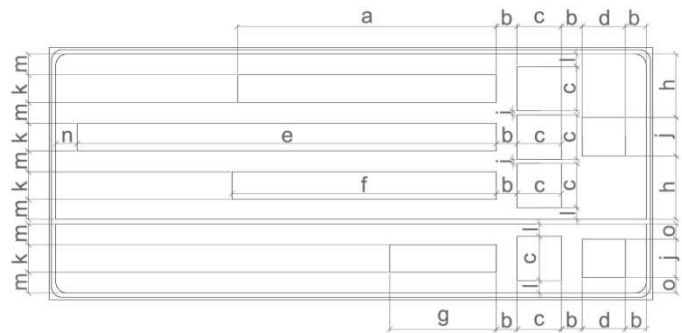

Fundo: Marrom
Tarja: Branco
Letra: Branco
Borda: Marrom
Pictograma: 200mm x 200mm

Seta: Tipo S3 / Cor: Branco



Fundo: Azul
Tarja: Branco
Letra: Branco
Borda: Azul
Pictograma: 200mm x 200mm

Seta: Tipo S1 / Cor: Branco

Contorno (mm)

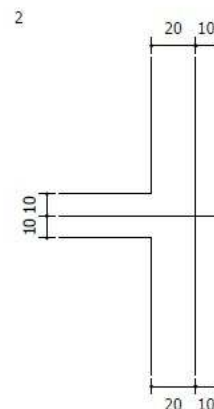
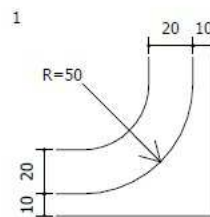

Fonte: Série E(m)

Altura (mm): 125

Cor: Branca

Largura (mm): 1171

101	83	83	100	25	83	83	83
G	u	a	x	i	n	d	u
	38	39	39	39	50	39	50
							36

96	83
v	a
	25

Fonte: Série E(m)

Altura (mm): 125

Cor: Branca

Largura (mm): 1896

101	25	125	83	83	125	101	83
C	.		d	e		C	u
	15	0	0	39	0	0	35
							50

25	65	25	125	83	125	93	83
l	t	.		e		L	a
	36	20	0	0	0	0	16
							40

85	83	63
z	e	r
	29	39

Fonte: Série E(m)

Altura (mm): 125

Cor: Branca

Largura (mm): 1196

101	83	25	93	83	85	25	85
P	q	.	E	c	o	l	ó
	19	30	23	23	28	39	39
							28

83	25	83	85
g	i	c	o
	50	39	28

Fonte: Série E(m)

Altura (mm): 125

Cor: Branca

Largura (mm): 483

101	85	65	83	25
H	o	t	e	l
	31	25	29	39

Placa – 19 (Suporte P57)



Status: Implementar
Dimensões: 2,70m x 1,15m



Tabela de cotas (mm):

a	b	c	d	e	f	g	h	i	j	k	l	m	n
87	195	200	1896	88	1196	125	1643	20	1683	95	57,5	175	180

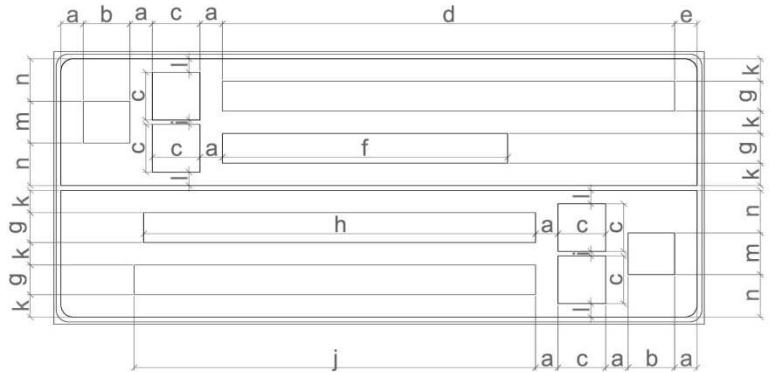
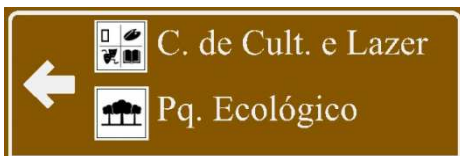

Fundo: Marrom
Tarja: Branco
Letra: Branco
Borda: Marrom
Pictograma: 200mm x 200mm

Seta: Tipo S3 / Cor: Branco



Fundo: Marrom
Tarja: Branco
Letra: Branco
Borda: Marrom
Pictograma: 200mm x 200mm

Seta: Tipo S3 / Cor: Branco

Contorno (mm)

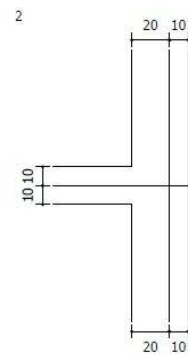
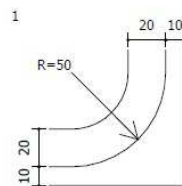

Fonte: Série E(m)
 Altura (mm): 125
 Cor: Branca
 Largura (mm): 1896

101	25	125	83	83	125	101	83
C	.		d	e		C	u
	15	0	0	39	0	0	35
25	65	25	125	83	125	93	83
l	t	.		e		L	a
	36	20	0	0	0	0	16
85	83	63					
z	e	r					
	29	39					

Fonte: Série E(m)
 Altura (mm): 125
 Cor: Branca
 Largura (mm): 1196

101	83	25	93	83	85	25	85
P	q	.	E	c	o	l	ó
	19	30	23	23	28	39	39
83	25	83	85				
g	i	c	o				
	50	39	28				

Fonte: Série E(m)
 Altura (mm): 125
 Cor: Branca
 Largura (mm): 1643

101	83	83	65	63	85	125	101
C	e	n	t	r	o		H
	24	39	36	40	19	0	43
25	83	65	85	63	25	83	85
i	s	t	ó	r	i	c	o
	36	25	29	39	30	39	28

Fonte: Série E(m)
 Altura (mm): 125
 Cor: Branca
 Largura (mm): 1683

93	83	65	83	83	83	85	125
E	s	t	a	ç	ã	o	
	20	25	29	39	28	39	0
101	83	25	65	83	63	83	25
C	u	l	t	u	r	a	l
	35	50	36	40	50	19	50

Placa – 20 (Suporte P57)



Status: Implementar
Dimensões: 2,45m x 1,15m



Tabela de cotas (mm):

a	b	c	d	e	f	g	h	i	j	k	l	m	n
83	195	200	1578	95	1683	125	1320	20	70	280	57,5	1643	175

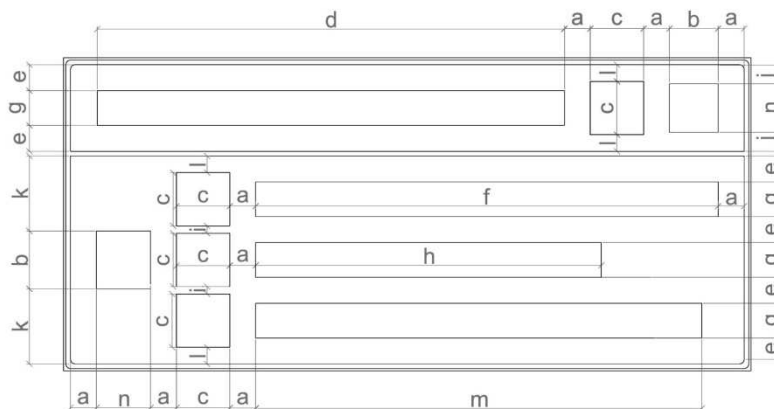

Fundo: Marrom
Tarja: Branco
Letra: Branco
Borda: Marrom
Pictograma: 200mm x 200mm

Seta: Tipo S1 / Cor: Branco



Fundo: Marrom
Tarja: Branco
Letra: Branco
Borda: Marrom
Pictograma: 200mm x 200mm

Seta: Tipo S2 / Cor: Branco

Contorno (mm)

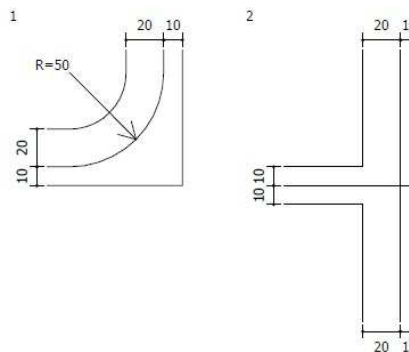

Fonte: Série E(m)
 Altura (mm): 125
 Cor: Branca
 Largura (mm): 1578

101	25	125	83	83	125	116	83	
C	.		d	e		M	e	
	15	0	0	39	0	0	31	28

83	25	65	83	83	83	85
d	i	t	a	ç	ã	o
	50	36	29	39	28	39

Fonte: Série E(m)
 Altura (mm): 125
 Cor: Branca
 Largura (mm): 1683

93	83	65	83	83	83	85	125	
E	s	t	a	ç	ã	o		
	20	25	29	39	28	39	0	0

101	83	25	65	83	63	83	25
C	u	l	t	u	r	a	l
	35	50	36	40	50	19	50

Fonte: Série E(m)
 Altura (mm): 125
 Cor: Branca
 Largura (mm): 1320

101	83	83	125	83	83	125	101	
P	ç	a		d	a		B	
	19	28	0	0	39	0	0	35

25	83	25	25	83
i	b	l	i	a
	50	39	50	39

Fonte: Série E(m)
 Altura (mm): 125
 Cor: Branca
 Largura (mm): 1643

101	83	83	65	63	85	125	101	
C	e	n	t	r	o		H	
	24	39	36	40	19	0	0	43

25	83	65	85	63	25	83	85
i	s	t	ó	r	i	c	o
	36	25	29	39	30	39	28

Placa – 21 (Suporte P55)



Status: Implementar
Dimensões: 2,40m x 0,60m



Tabela de cotas (mm):

a	b	c	d	e	f	g	h	i	j	k	l	m	n
92	195	200	1171	1578	91	125	175	23	182,5	96	58,5	379	98

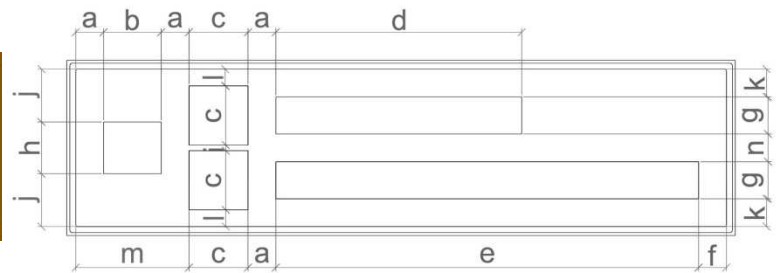

Fundo: Marrom
Tarja: Branco
Letra: Branco
Borda: Marrom
Pictograma: 200mm x 200mm

Seta: Tipo S3 / Cor: Branco

Contorno (mm)

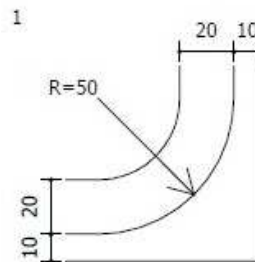

Fonte: Série E(m)
Altura (mm): 125
Cor: Branca
Largura (mm): 1171

101	83	83	100	25	83	83	83
G	u	a	x	i	n	d	u
	38	39	39	39	50	39	50
							36
96	83						
v	a						
	25						

Fonte: Série E(m)
Altura (mm): 125
Cor: Branca
Largura (mm): 1578

101	25	125	83	83	125	116	83
C	.		d	e		M	e
	15	0	0	39	0	0	31
							28
83	25	65	83	83	83	85	
d	i	t	a	ç	ã	o	
	50	36	29	39	28	39	

Placa – 22 (Suporte P55)



Status: Implementar
Dimensões: 2,75m x 0,90m



Tabela de cotas (mm):

a	b	c	d	e	f	g	h	i	j	k	l	m	n
92	1896	200	226	1196	145,5	125	1171	14	195	89	51,5	175	54

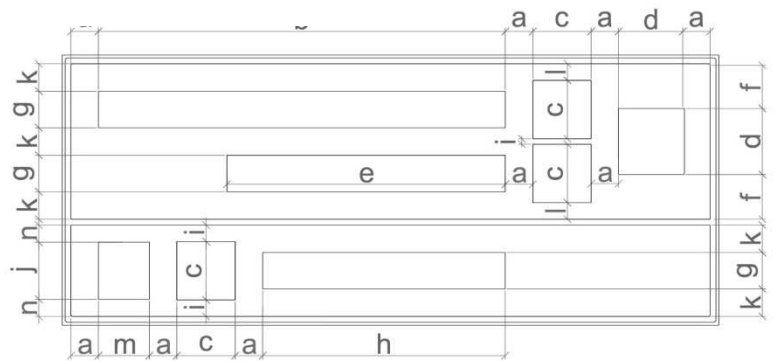

Fundo: Marrom
Tarja: Branco
Letra: Branco
Borda: Marrom
Pictograma: 200mm x 200mm

Seta: Tipo S2 / Cor: Branco



Fundo: Marrom
Tarja: Branco
Letra: Branco
Borda: Marrom
Pictograma: 200mm x 200mm

Seta: Tipo S1 / Cor: Branco

Contorno (mm)

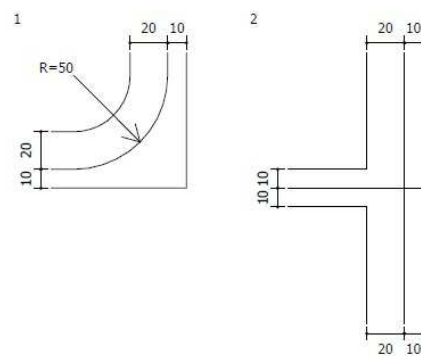

Fonte: Série E(m)
 Altura (mm): 125
 Cor: Branca
 Largura (mm): 1896

101	25	125	83	83	125	101	83
C	.		d	e		C	u
	15	0	0	39	0	0	35

25	65	25	125	83	125	93	83
l	t	.		e		L	a
	36	20	0	0	0	0	16

85	83	63
z	e	r
	29	39

Fonte: Série E(m)
 Altura (mm): 125
 Cor: Branca
 Largura (mm): 1196

101	83	25	93	83	85	25	85
P	q	.	E	c	o	l	ó
	19	30	23	23	28	39	39

83	25	83	85
g	i	c	o
	50	39	28

Fonte: Série E(m)
 Altura (mm): 125
 Cor: Branca
 Largura (mm): 1171

101	83	83	100	25	83	83	83
G	u	a	x	i	n	d	u
	38	39	39	39	50	39	50

96	83
v	a
	25

Placa – 23 (Suporte P53)



Status: Implementar
 Dimensões: 1,40m x 0,75m



Tabela de cotas (mm):

a	b	c	d	e	f	g	h
570	200	72,5	100	994	173	1185	77,5

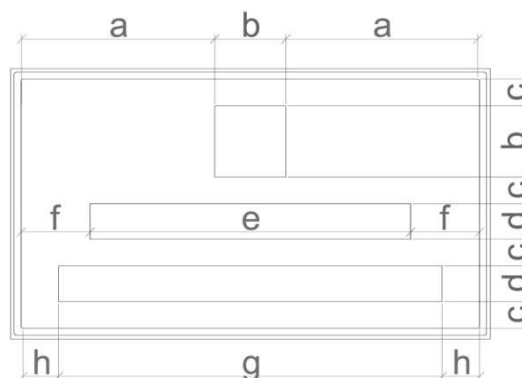

Fundo: Marrom
 Tarja: Branco
 Letra: Branco
 Borda: Marrom
 Pictograma: 200mm x 200mm

Contorno (mm)

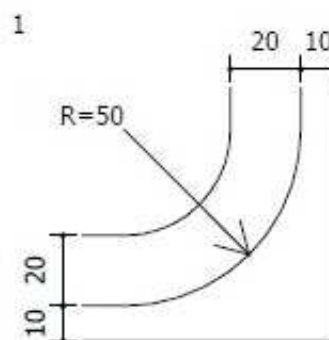

Fonte: Série E(m)

Altura (mm): 100

Cor: Branca

Largura (mm): 994

81	20	100	66	66	100	81	66	
C	.		d	e		C	u	
	12	0	0	31	0	0	28	40

20	52	20	100	66
l	t	.		e
	29	16	0	0

Fonte: Série E(m)

Altura (mm): 100

Cor: Branca

Largura (mm): 1185

74	66	68	66	50	100	81	20	
L	a	z	e	r		S	.	
	13	32	23	31	0	0	15	0

100	81	68	77	66	66
	C	o	v	a	s
	0	19	20	20	29

Placa – 24 (Suporte P53)



Status: Implementar
Dimensões: 1,15m x 0,75m



Tabela de cotas (mm):

a	b	c	d	e	f	g	h
305	200	77,5	100	957	76,5	891	109,5

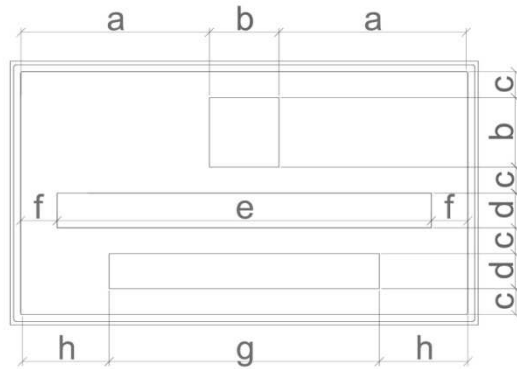

Fundo: Marrom
Tarja: Branco
Letra: Branco
Borda: Marrom
Pictograma: 200mm x 200mm

Contorno (mm)

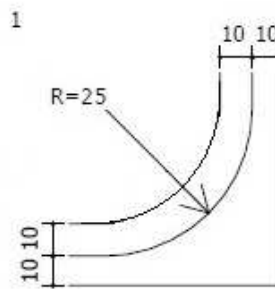

Fonte: Série E(m)

Altura (mm): 100

Cor: Branca

Largura (mm): 957

81	66	20	74	66	68	20	68	
P	q	.	E	c	o	l	ó	
	15	24	18	18	22	31	31	22
66	20	66	68					
g	i	c	o					
	40	31	22					

Fonte: Série E(m)

Altura (mm): 100

Cor: Branca

Largura (mm): 891

81	20	100	66	68	100	66	20	
R	.		d	o		P	i	
	11	4	11	31	11	20	31	40
50	66	20						
r	a	í						
	15	40						

Placa – 25 e 26 (Suporte P53)

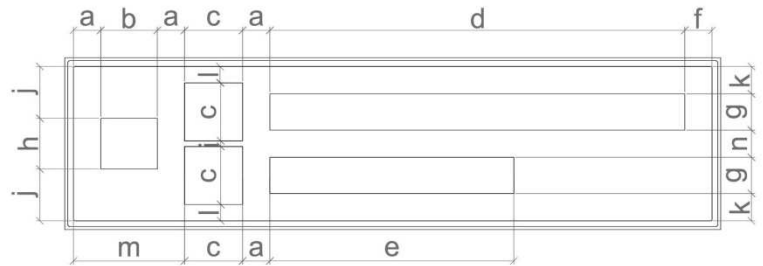
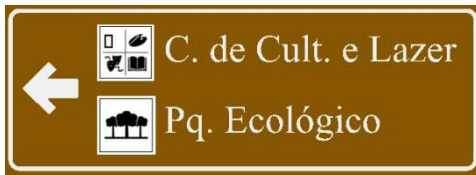

Status: Implementar
Dimensões: 2,75m x 0,60m

Tabela de cotas (mm):

a	b	c	d	e	f	g	h	i	j	k	l	m	n
100	195	200	1896	1196	99	125	175	23	182,5	96	58,5	395	98

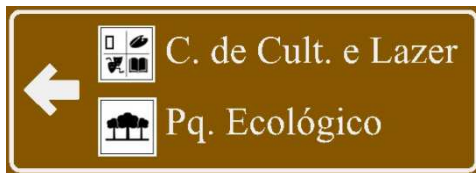

Fundo: Marrom
Tarja: Branco
Letra: Branco
Borda: Marrom
Pictograma: 200mm x 200mm

Seta: Tipo S3 / Cor: Branco

Contorno (mm)

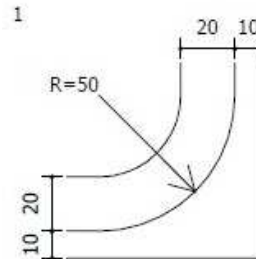
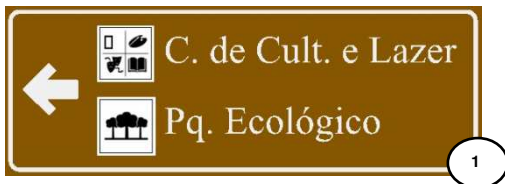

Fonte: Série E(m)

Altura (mm): 125

Cor: Branca

Largura (mm): 1896

101	25	125	83	83	125	101	83
C	.		d	e		C	u
	15	0	0	39	0	0	35
							50

25	65	25	125	83	125	93	83
l	t	.		e		L	a
	36	20	0	0	0	0	16
							40

85	83	63
z	e	r
	29	39

Fonte: Série E(m)

Altura (mm): 125

Cor: Branca

Largura (mm): 1196

101	83	25	93	83	85	25	85
P	q	.	E	c	o	l	ó
19	30	23	23	28	39	39	28

83	25	83	85
g	i	c	o
50	39	28	

Placa – 27 (Suporte P55)



Status: Implementar
Dimensões: 2,70m x 1,15m



Tabela de cotas (mm):

a	b	c	d	e	f	g	h	i	j	k	l	m	n	o
87	195	200	1896	88	1196	125	1683	20	1578	95	57,5	175	170	180

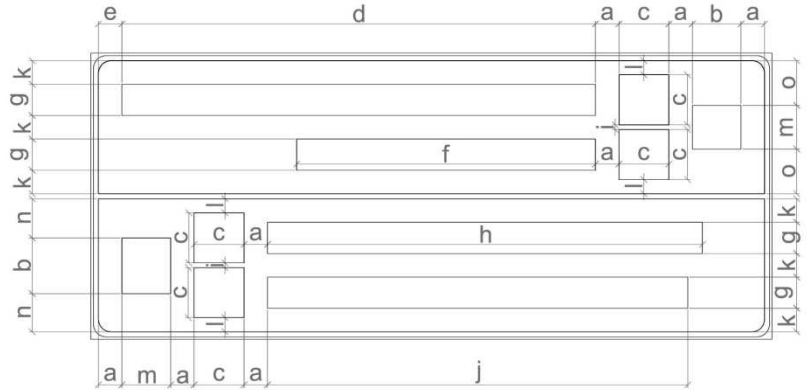

Fundo: Marrom
Tarja: Branco
Letra: Branco
Borda: Marrom
Pictograma: 200mm x 200mm

Seta: Tipo S3 / Cor: Branco



Fundo: Marrom
Tarja: Branco
Letra: Branco
Borda: Marrom
Pictograma: 200mm x 200mm

Seta: Tipo S2 / Cor: Branco

Contorno (mm)

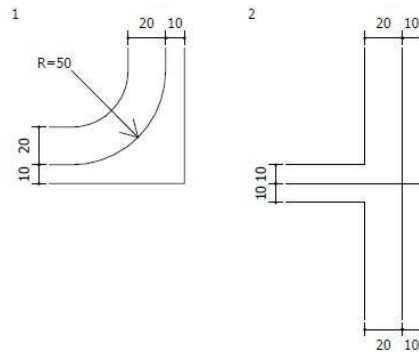

Fonte: Série E(m)
 Altura (mm): 125
 Cor: Branca
 Largura (mm): 1896

101	25	125	83	83	125	101	83
C	.		d	e		C	u
	15	0	0	39	0	0	35
25	65	25	125	83	125	93	83
l	t	.		e		L	a
	36	20	0	0	0	0	16
85	83	63					
z	e	r					
	29	39					

Fonte: Série E(m)
 Altura (mm): 125
 Cor: Branca
 Largura (mm): 1196

101	83	25	93	83	85	25	85
P	q	.	E	c	o	l	ó
	19	30	23	23	28	39	39
83	25	83	85				
g	i	c	o				
	50	39	28				

Fonte: Série E(m)
 Altura (mm): 125
 Cor: Branca
 Largura (mm): 1683

93	83	65	83	83	83	85	125
E	s	t	a	ç	ã	o	
	20	25	29	39	28	39	0
101	83	25	65	83	63	83	25
C	u	l	t	u	r	a	l
	35	50	36	40	50	19	50

Fonte: Série E(m)
 Altura (mm): 125
 Cor: Branca
 Largura (mm): 1578

101	25	125	83	83	125	116	83
C	.		d	e		M	e
	15	0	0	39	0	0	31
83	25	65	83	83	83	85	
d	i	t	a	ç	ã	o	
	50	36	29	39	28	39	

Placa – 28 (Suporte P55)



Status: Implementar
Dimensões: 1,90m x 0,90m



Tabela de cotas (mm):

a	b	c	d	e	f	g	h	i	j	k	l	m	n
96	175	200	984	1080	97	483	89	14	195	64	51,5	161	125

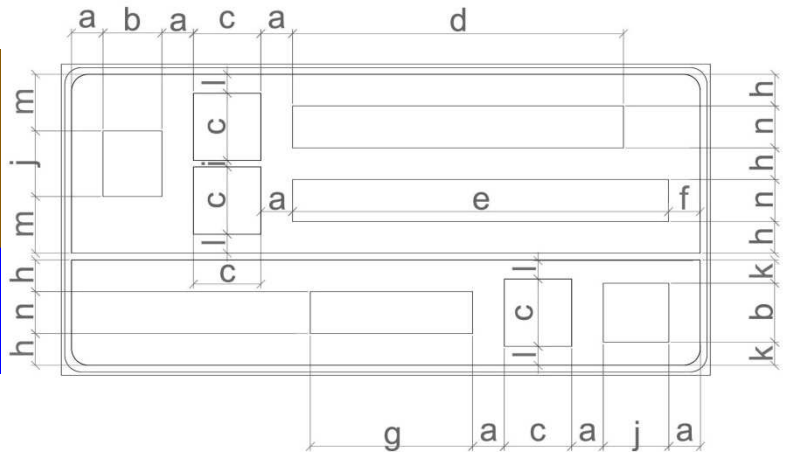

Fundo: Marrom
Tarja: Branco
Letra: Branco
Borda: Marrom
Pictograma: 200mm x 200mm

Seta: Tipo S2 / Cor: Branco



Fundo: Azul
Tarja: Branco
Letra: Branco
Borda: Azul
Pictograma: 200mm x 200mm

Seta: Tipo S1 / Cor: Branco

Contorno (mm)

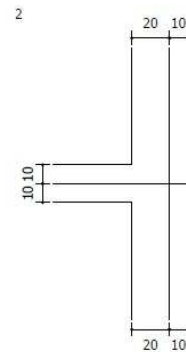
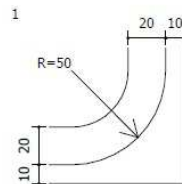
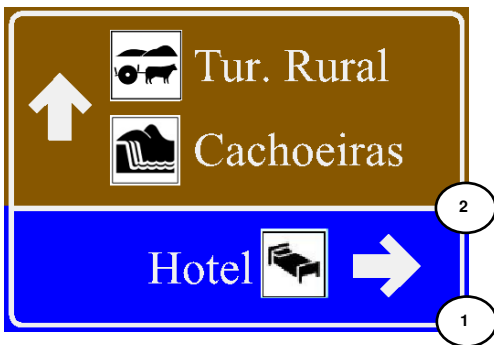

Fonte: Série E(m)

Altura (mm): 125

Cor: Branca

Largura (mm): 984

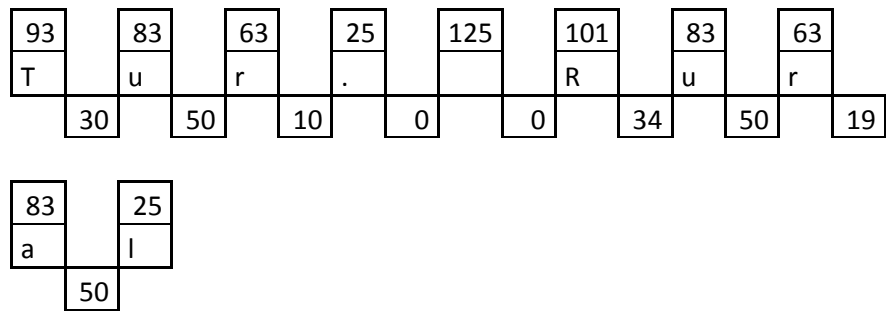

Fonte: Série E(m)

Altura (mm): 125

Cor: Branca

Largura (mm): 1080

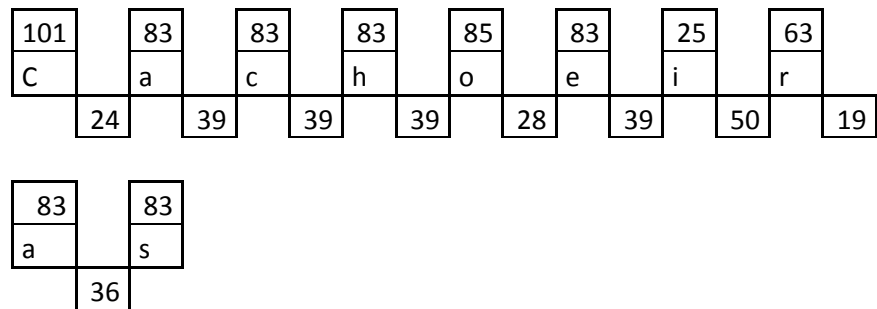

Fonte: Série E(m)

Altura (mm): 125

Cor: Branca

Largura (mm): 483

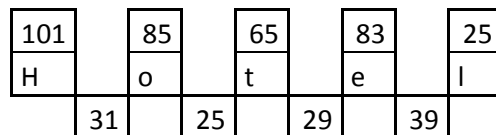

Placa – 29 (Suporte P55)



Status: Implementar
Dimensões: 2,75m x 0,90m



Tabela de cotas (mm):

a	b	c	d	e	f	g	h	i	j	k	l	m	n
100	195	200	1896	99	1196	1171	89	14	175	64	51,5	171	125

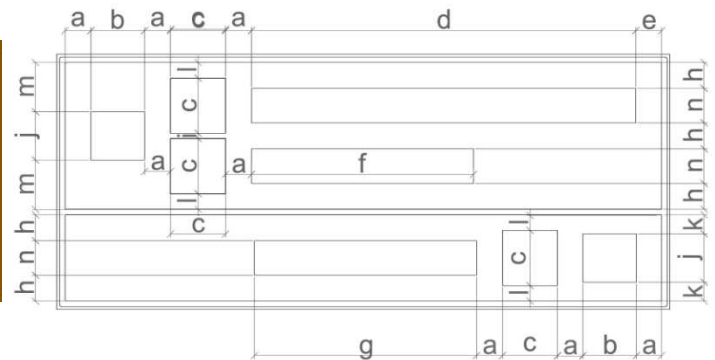
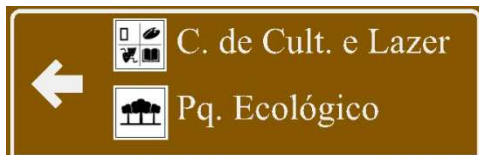

Fundo: Marrom
Tarja: Branco
Letra: Branco
Borda: Marrom
Pictograma: 200mm x 200mm

Seta: Tipo S3 / Cor: Branco



Fundo: Marrom
Tarja: Branco
Letra: Branco
Borda: Marrom
Pictograma: 200mm x 200mm

Seta: Tipo S1 / Cor: Branco

Contorno (mm)

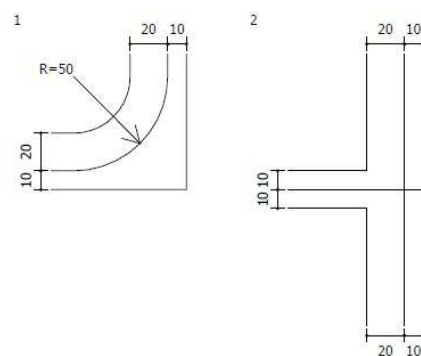

Fonte: Série E(m)

Altura (mm): 125

Cor: Branca

Largura (mm): 1896

101	25	125	83	83	125	101	83	
C	.		d	e		C	u	
	15	0	0	39	0	0	35	50

25	65	25	125	83	125	93	83	
l	t	.		e		L	a	
	36	20	0	0	0	0	16	40

85	83	63
z	e	r
	29	39

Fonte: Série E(m)

Altura (mm): 125

Cor: Branca

Largura (mm): 1196

101	83	25	93	83	85	25	85	
P	q	.	E	c	o	l	ó	
	19	30	23	23	28	39	39	28

83	25	83	85
g	i	c	o
	50	39	28

Fonte: Série E(m)

Altura (mm): 125

Cor: Branca

Largura (mm): 1171

101	83	83	100	25	83	83	83	
G	u	a	x	i	n	d	u	
	38	39	39	39	50	39	50	36

96	83
v	a
	25

Placa – 30 (Suporte P55)



Status: Implementar
Dimensões: 2,40m x 0,60m



Tabela de cotas (mm):

a	b	c	d	e	f	g	h	i	j	k	l	m
97	175	200	1171	1578	96	125	195	23	172,5	98	58,5	369

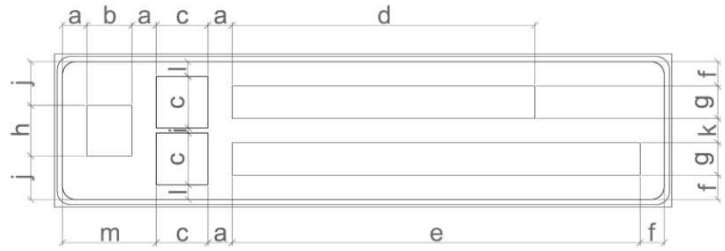

Fundo: Marrom
Tarja: Branco
Letra: Branco
Borda: Marrom
Pictograma: 200mm x 200mm

Seta: Tipo S2 / Cor: Branco

Contorno (mm)

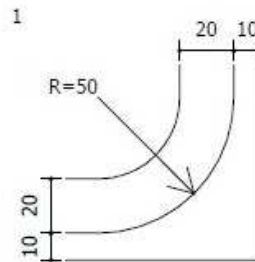

Fonte: Série E(m)

Altura (mm): 125

Cor: Branca

Largura (mm): 1171

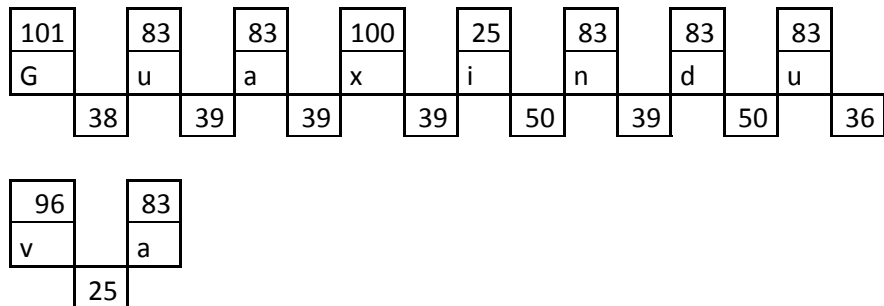

Fonte: Série E(m)

Altura (mm): 125

Cor: Branca

Largura (mm): 1578

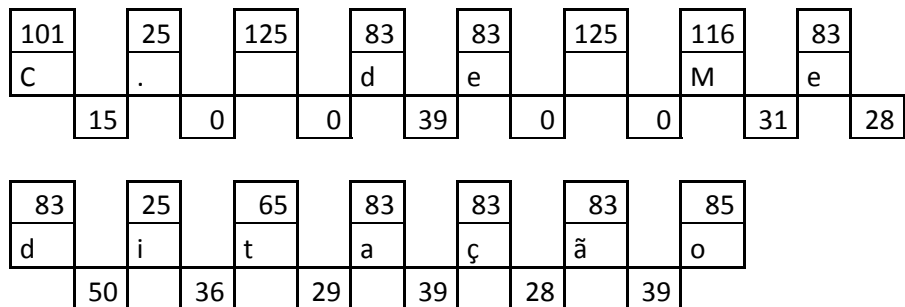

Placa – 31 (Suporte P53)

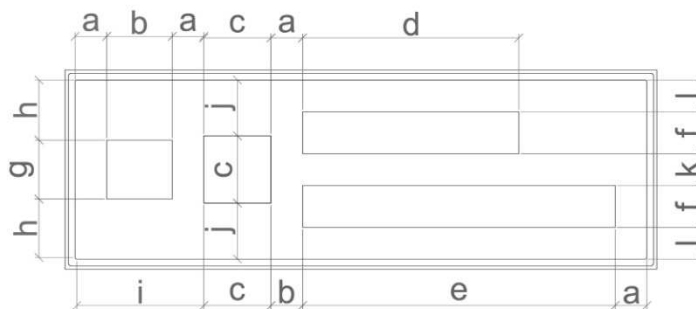

Status: Implementar
Dimensões: 1,75m x 0,55m

Tabela de cotas (mm):

a	b	c	d	e	f	g	h	i	j	k	l
83	195	200	965	983	125	175	167,5	361	155	86	87



Fundo: Marrom
Tarja: Branco
Letra: Branco
Borda: Marrom
Pictograma: 200mm x 200mm

Seta: Tipo S3 / Cor: Branco

Contorno (mm)

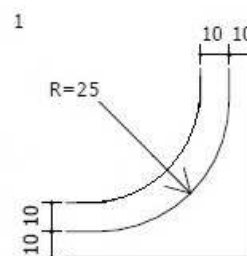

Fonte: Série E(m)

Altura (mm): 125

Cor: Branca

Largura (mm): 965

101	83	83	65	63	85	125	83	
C	e	n	t	r	o		d	
	24	39	36	40	19	0	0	39
83								
e								

Fonte: Série E(m)

Altura (mm): 125

Cor: Branca

Largura (mm): 983

116	83	83	25	65	83	83	83	
M	e	d	i	t	a	ç	ã	
	31	28	50	36	29	39	28	39
85								
o								

Placa – 32 (Suporte P53)

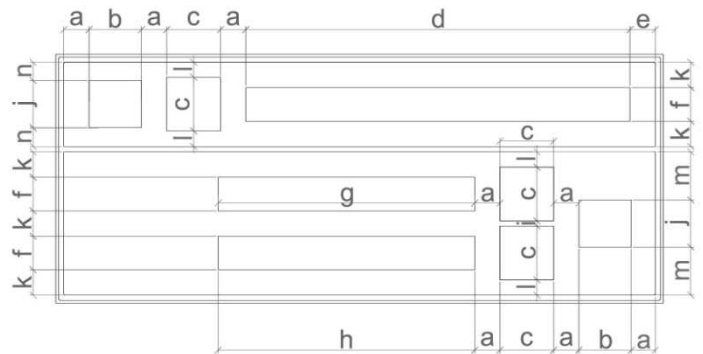

Status: Implementar
Dimensões: 2,40m x 0,90m

Tabela de cotas (mm):

a	b	c	d	e	f	g	h	i	j	k	l	m	n
92	195	200	1578	91	125	1171	1080	14	175	89	51,5	171	64



Fundo: Marrom
Tarja: Branco
Letra: Branco
Borda: Marrom
Pictograma: 200mm x 200mm

Seta: Tipo S1 / Cor: Branco



Fundo: Marrom
Tarja: Branco
Letra: Branco
Borda: Marrom
Pictograma: 200mm x 200mm

Seta: Tipo S3 / Cor: Branco

Contorno (mm)

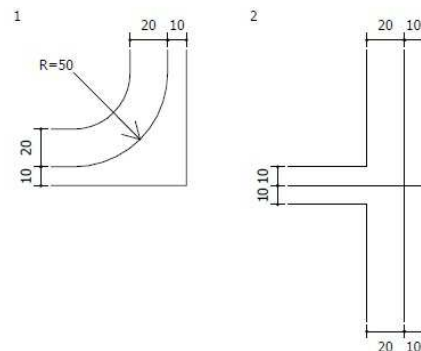

Fonte: Série E(m)

Altura (mm): 125

Cor: Branca

Largura (mm): 1578

101	25	125	83	83	125	116	83	
C	.		d	e		M	e	
	15	0	0	39	0	0	31	28

83	25	65	83	83	83	85
d	i	t	a	ç	ã	o
	50	36	29	39	28	39

Fonte: Série E(m)

Altura (mm): 125

Cor: Branca

Largura (mm): 1171

101	83	83	100	25	83	83	83	
G	u	a	x	i	n	d	u	
	38	39	39	39	50	39	50	36

96	83
v	a
	25

Fonte: Série E(m)

Altura (mm): 125

Cor: Branca

Largura (mm): 1080

101	83	83	83	85	83	25	63	
C	a	c	h	o	e	i	r	
	24	39	39	39	28	39	50	19

83	83
a	s
	36

Placa – 33 (Suporte P53)

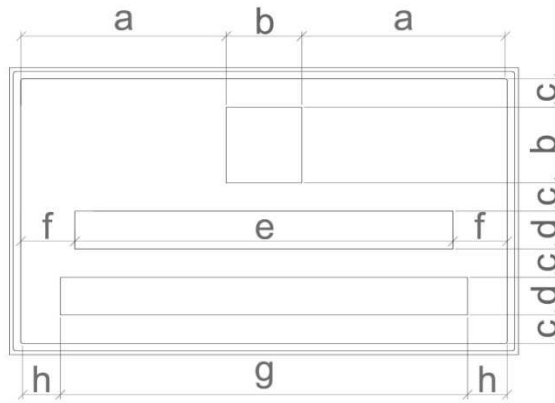

Status: Implementar
Dimensões: 1,30m x 0,75m

Tabela de cotas (mm):

a	b	c	d	e	f	g	h
530	200	77,5	100	1034	113	1113	73,5



Fundo: Marrom
Tarja: Branco
Letra: Branco
Borda: Marrom
Pictograma: 200mm x 200mm

Contorno (mm)

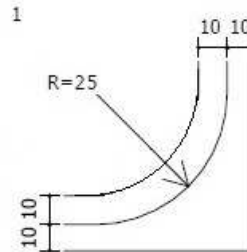

Fonte: Série E(m)

Altura (mm): 100

Cor: Branca

Largura (mm): 1034

20	66	50	20	81	52	56	20
l	g	r	.	S	t	a	.
	25	40	8	15	20	20	12
							14

81	50	66	68	100	66
C	r	u	z		e
	28	24	32	0	0

Fonte: Série E(m)

Altura (mm): 100

Cor: Branca

Largura (mm): 1113

81	20	81	56	20	101	66	66
N	.	S	a	.	A	p	a
	18	15	19	12	8	24	22
							40

50	66	66	20	66	66
r	e	c	i	d	a
	15	22	31	31	31

Placa – 34 (Suporte P53)

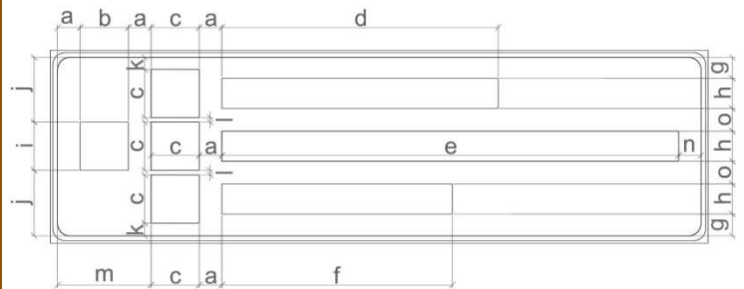

Status: Implementar
Dimensões: 2,65m x 0,80m

Tabela de cotas (mm):

a	b	c	d	e	f	g	h	i	j	k	l	m	n	o
97	195	200	1171	1808	984	90,5	125	175	282,5	53	17	389	96	92



Fundo: Marrom
Tarja: Branco
Letra: Branco
Borda: Marrom
Pictograma: 200mm x 200mm

Seta: Tipo S3 / Cor: Branco

Contorno (mm)

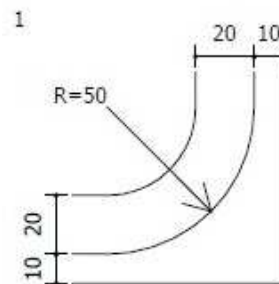

Fonte: Série E(m)
 Altura (mm): 125
 Cor: Branca
 Largura (mm): 1171

101	83	83	100	25	83	83	83
G	u	a	x	i	n	d	u
	38	39	39	39	50	39	50
							36

96	83
v	a
	25

Fonte: Série E(m)
 Altura (mm): 125
 Cor: Branca
 Largura (mm): 1808

101	65	70	25	101	63	83	85
S	t	a	.	C	r	u	z
	25	25	15	18	35	30	40
							0

125	83	125	101	25	101	70	25
	e		N	.	S	a	.
	0	0	0	23	19	24	15
							10

126	83	25
A	p	.
	30	19

Fonte: Série E(m)
 Altura (mm): 125
 Cor: Branca
 Largura (mm): 984

93	83	63	25	125	101	83	63
T	u	r	.		R	u	r
	30	50	10	0	0	34	50
							19

83	25
a	l
	50

Placa – 35 (Suporte P53)

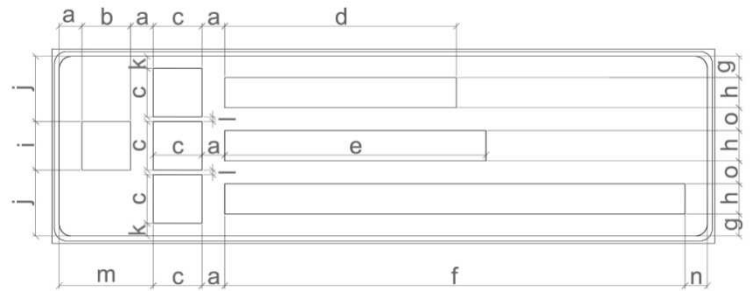

Status: Implementar
Dimensões: 2,65m x 0,80m

Tabela de cotas (mm):

a	b	c	d	e	f	g	h	i	j	k	l	m	n	o
97	195	200	1080	1171	1808	90,5	125	175	282,5	53	17	389	96	92

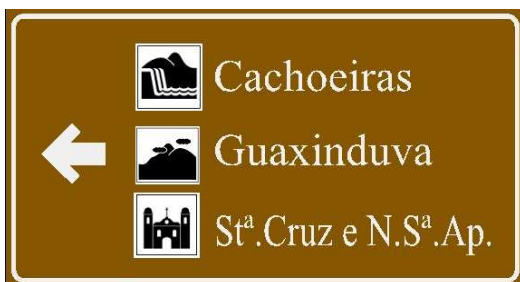

Fundo: Marrom
Tarja: Branco
Letra: Branco
Borda: Marrom
Pictograma: 200mm x 200mm

Seta: Tipo S3 / Cor: Branco

Contorno (mm)

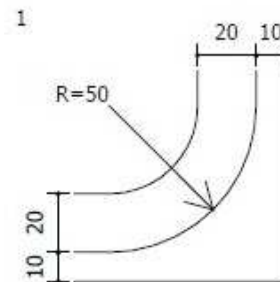

Fonte: Série E(m)
 Altura (mm): 125
 Cor: Branca
 Largura (mm): 1080

101	83	83	83	85	83	25	63	
C	a	c	h	o	e	i	r	
	24	39	39	39	28	39	50	19

83	83
a	s
	36

Fonte: Série E(m)
 Altura (mm): 125
 Cor: Branca
 Largura (mm): 1171

101	83	83	100	25	83	83	83	
G	u	a	x	i	n	d	u	
	38	39	39	39	50	39	50	36

96	83
v	a
	25

Fonte: Série E(m)
 Altura (mm): 125
 Cor: Branca
 Largura (mm): 1808

101	65	70	25	101	63	83	85	
S	t	ã	.	C	r	u	z	
	25	25	15	18	35	30	40	0

125	83	125	101	25	101	70	25	
	e		N	.	S	ã	.	
	0	0	0	23	19	24	15	10

126	83	25
A	p	.
	30	19

Placa – 36 (Suporte P55)



Status: Implementar
Dimensões: 2,65m x 0,80m

Tabela de cotas (mm):

a	b	c	d	e	f	g	h	i	j	k	l	m	n	o
97	195	200	1080	1171	1808	90,5	125	175	282,5	53	17	389	96	92

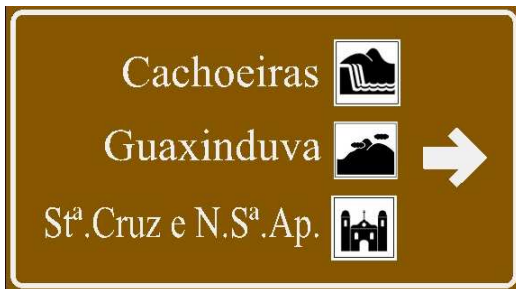
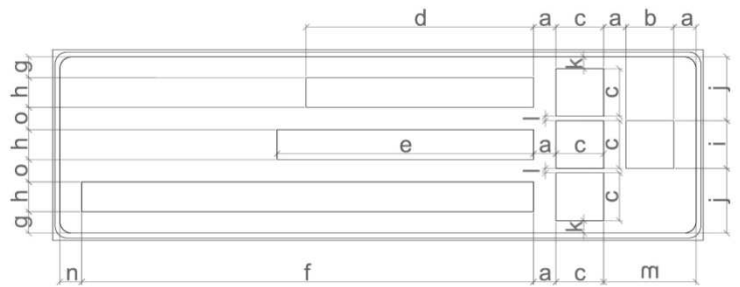

Fundo: Marrom
Tarja: Branco
Letra: Branco
Borda: Marrom
Pictograma: 200mm x 200mm

Seta: Tipo S3 / Cor: Branco

Contorno (mm)

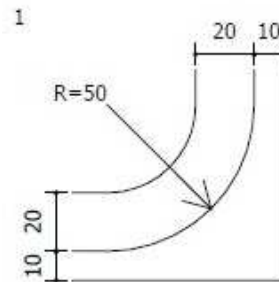

Fonte: Série E(m)
 Altura (mm): 125
 Cor: Branca
 Largura (mm): 1080

101	83	83	83	85	83	25	63	
C	a	c	h	o	e	i	r	
	24	39	39	39	28	39	50	19

83	83
a	s
	36

Fonte: Série E(m)
 Altura (mm): 125
 Cor: Branca
 Largura (mm): 1171

101	83	83	100	25	83	83	83	
G	u	a	x	i	n	d	u	
	38	39	39	39	50	39	50	36

96	83
v	a
	25

Fonte: Série E(m)
 Altura (mm): 125
 Cor: Branca
 Largura (mm): 1808

101	65	70	25	101	63	83	85	
S	t	ã	.	C	r	u	z	
	25	25	15	18	35	30	40	0

125	83	125	101	25	101	70	25	
	e		N	.	S	ã	.	
	0	0	0	23	19	24	15	10

126	83	25
A	p	.
	30	19

Placa – 37 (Suporte P55)

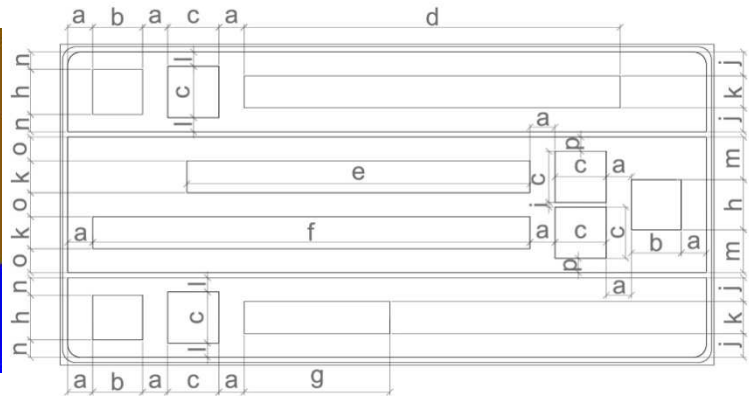

Status: Implementar
Dimensões: 2,25m x 1,25m

Tabela de cotas (mm):

a	b	c	d	e	f	g	h	i	j	k	l	m	n	o	p
93	195	200	1196	1171	1423	483	175	19	92	125	54,5	178,5	67	94	56,5



Fundo: Marrom
Tarja: Branco
Letra: Branco
Borda: Marrom
Pictograma: 200mm x 200mm

Seta: Tipo S1 / Cor: Branco



Fundo: Marrom
Tarja: Branco
Letra: Branco
Borda: Marrom
Pictograma: 200mm x 200mm

Seta: Tipo S3 / Cor: Branco



Fundo: Azul
Tarja: Branco
Letra: Branco
Borda: Azul
Pictograma: 200mm x 200mm

Seta: Tipo S1 / Cor: Branco

Contorno (mm)

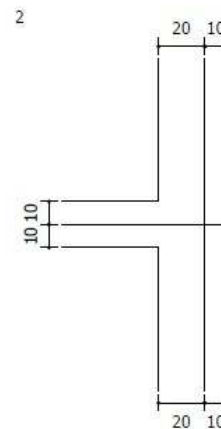
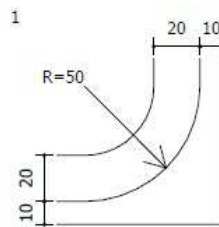

Fonte: Série E(m)
 Altura (mm): 125
 Cor: Branca
 Largura (mm): 1196

101	83	25	93	83	85	25	85
P	q	.	E	c	o	l	ó
	19	30	23	23	28	39	39
							28

83	25	83	85
g	i	c	o
	50	39	28

Fonte: Série E(m)
 Altura (mm): 125
 Cor: Branca
 Largura (mm): 1171

101	83	83	100	25	83	83	83
G	u	a	x	i	n	d	u
	38	39	39	39	50	39	50
							36

96	83
v	a
	25

Fonte: Série E(m)
 Altura (mm): 125
 Cor: Branca
 Largura (mm): 1423

101	25	95	25	125	83	85	125
B	.	J	.		d	o	
	15	10	23	0	0	39	0
							0

101	85	83	53	25	138
B	o	n	f	i	m
	24	39	38	39	50

Fonte: Série E(m)
 Altura (mm): 125
 Cor: Branca
 Largura (mm): 483

101	85	65	83	25
H	o	t	e	l
	31	25	29	39

Placa – 38 (Suporte P55)

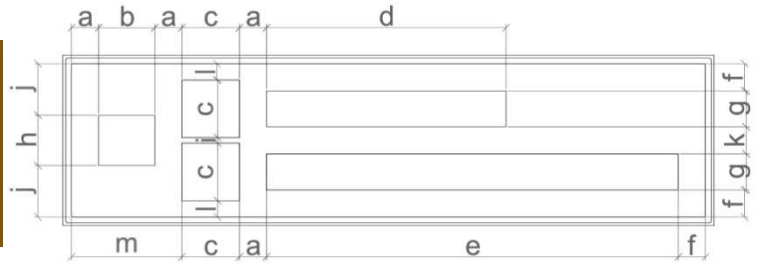

Status: Implementar
Dimensões: 2,65m x 0,60m

Tabela de cotas (mm):

a	b	c	d	e	f	g	h	i	j	k	l	m
97	195	200	1171	1808	96	125	175	23	182,5	98	58,5	389



Fundo: Marrom
Tarja: Branco
Letra: Branco
Borda: Marrom
Pictograma: 200mm x 200mm
Seta: Tipo S3 / Cor: Branco

Contorno (mm)

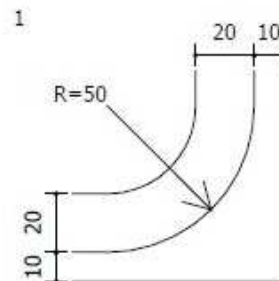

Fonte: Série E(m)

Altura (mm): 125

Cor: Branca

Largura (mm): 1171

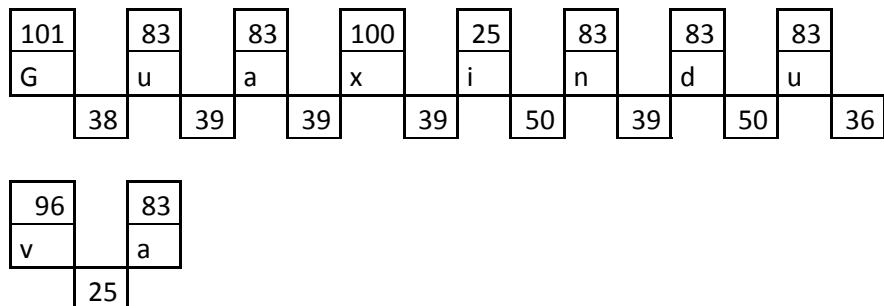

Fonte: Série E(m)

Altura (mm): 125

Cor: Branca

Largura (mm): 1808

101	65	70	25	101	63	83	85
S	t	a	.	C	r	u	z
	25	25	15	18	35	30	40
							0

125	83	125	101	25	101	70	25
	e		N	.	S	a	.
	0	0	0	23	19	24	15
							10

126	83	25
A	p	.
	30	19

Placa – 39 (Suporte P51)



Status: Implementar
Dimensões: 1,00m x 0,75m



Tabela de cotas (mm):

a	b	c	d	e	f	g	h
380	200	77,5	100	764	98	803	78,5

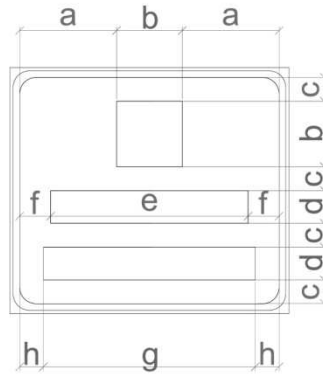

Fundo: Marrom
Tarja: Branco
Letra: Branco
Borda: Marrom
Pictograma: 200mm x 200mm

Contorno (mm)

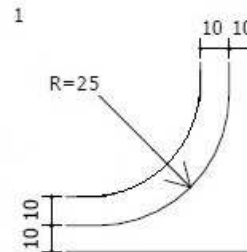

Fonte: Série E(m)

Altura (mm): 100

Cor: Branca

Largura (mm): 764

20	66	50	66	37	66	100	81	
l	g	r	e	j	a		B	
	25	40	15	13	31	0	0	12

20	76	20
.	J	.
	8	18

Fonte: Série E(m)

Altura (mm): 100

Cor: Branca

Largura (mm): 803

66	68	100	81	68	66	42	20	
d	o		B	o	n	f	i	
	31	11	14	19	31	30	31	40

110
m

Placa – 40 (Suporte P55)

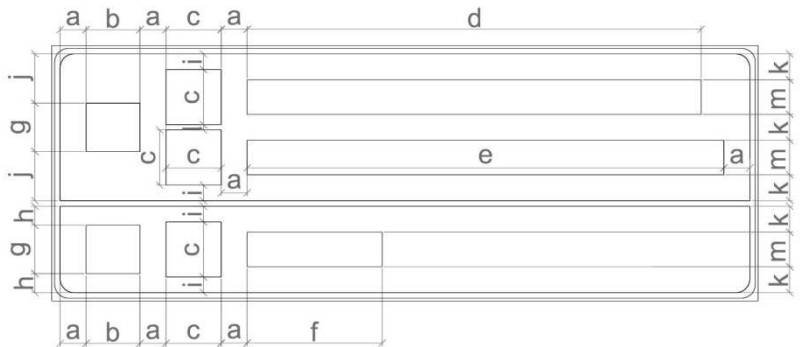

Status: Implementar
Dimensões: 2,25m x 0,90m

Tabela de cotas (mm):

a	b	c	d	e	f	g	h	i	j	k	l	m
93	195	200	1171	1423	483	175	64	51,5	171	89	14	125

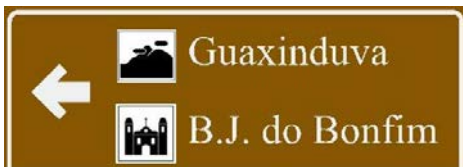

Fundo: Marrom
Tarja: Branco
Letra: Branco
Borda: Marrom
Pictograma: 200mm x 200mm

Seta: Tipo S3 / Cor: Branco



Fundo: Azul
Tarja: Branco
Letra: Branco
Borda: Azul
Pictograma: 200mm x 200mm

Seta: Tipo S1 / Cor: Branco

Contorno (mm)

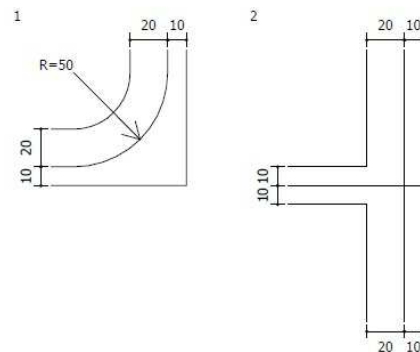

Fonte: Série E(m)
 Altura (mm): 125
 Cor: Branca
 Largura (mm): 1171

101	83	83	100	25	83	83	83
G	u	a	x	i	n	d	u
	38	39	39	39	50	39	50
							36

96	83
v	a
	25

Fonte: Série E(m)
 Altura (mm): 125
 Cor: Branca
 Largura (mm): 1423

101	25	95	25	125	83	85	125
B	.	J	.		d	o	
	15	10	23	0	0	39	0
							0

101	85	83	53	25	138
B	o	n	f	i	m
	24	39	38	39	50

Fonte: Série E(m)
 Altura (mm): 125
 Cor: Branca
 Largura (mm): 483

101	85	65	83	25
H	o	t	e	l
	31	25	29	39

Placa – 41 (Suporte P55)

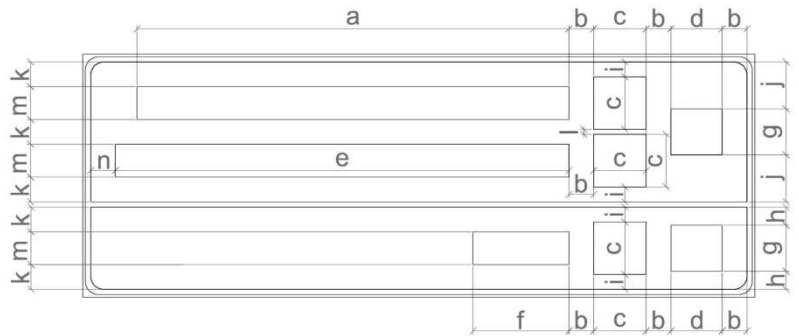

Status: Implementar
Dimensões: 2,50m x 0,90m

Tabela de cotas (mm):

a	b	c	d	e	f	g	h	i	j	k	l	m	n
1643	95	200	195	1664	305	175	64	51,5	171	89	14	125	96



Fundo: Marrom
Tarja: Branco
Letra: Branco
Borda: Marrom
Pictograma: 200mm x 200mm

Seta: Tipo S3 / Cor: Branco



Fundo: Azul
Tarja: Branco
Letra: Branco
Borda: Azul
Pictograma: 200mm x 200mm

Seta: Tipo S1 / Cor: Branco

Contorno (mm)

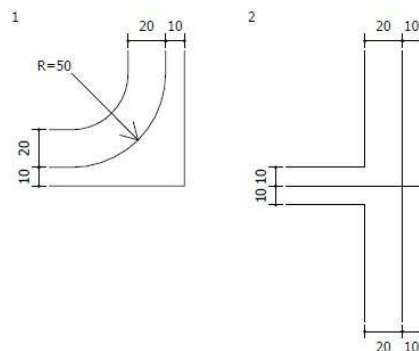

Fonte: Série E(m)
 Altura (mm): 125
 Cor: Branca
 Largura (mm): 1643

101	83	83	65	63	85	125	101	
C	e	n	t	r	o		H	
	24	39	36	40	19	0	0	43

25	83	65	85	63	25	83	85
i	s	t	ó	r	i	c	o
	36	25	29	39	30	39	28

Fonte: Série E(m)
 Altura (mm): 125
 Cor: Branca
 Largura (mm): 1664

101	65	70	25	125	101	25	125	
S	t	a	.		R	.		
	25	25	15	0	0	14	0	0

83	83	125	101	83	83	83	25	
d	e		C	a	s	s	i	
	39	0	0	24	36	25	39	39

83
a

Fonte: Série D
 Altura (mm): 125
 Cor: Branca
 Largura (mm): 305

85	85	106
S	P	A
	21	8

Placa – 42 (Suporte P51)



Status: Implementar
Dimensões: 1,15m x 0,75m



Tabela de cotas (mm):

a	b	c	d	e	f	g	h
455	200	77,5	100	790	160	970	70

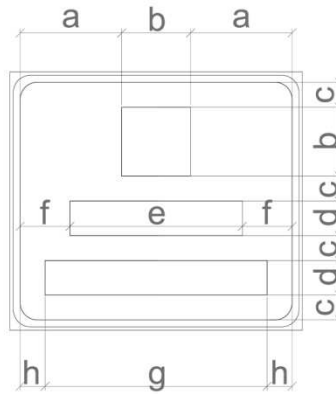

Fundo: Marrom
Tarja: Branco
Letra: Branco
Borda: Marrom
Pictograma: 200mm x 200mm

Contorno (mm)

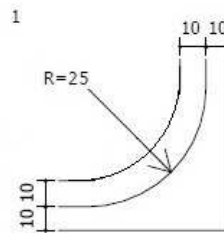
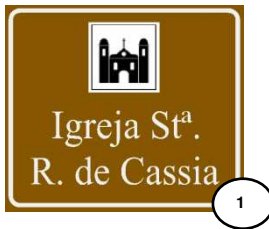

Fonte: Série E(m)

Altura (mm): 100

Cor: Branca

Largura (mm): 790

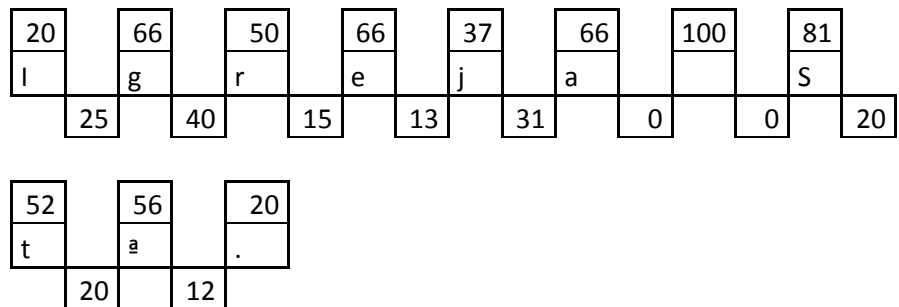

Fonte: Série E(m)

Altura (mm): 100

Cor: Branca

Largura (mm): 970

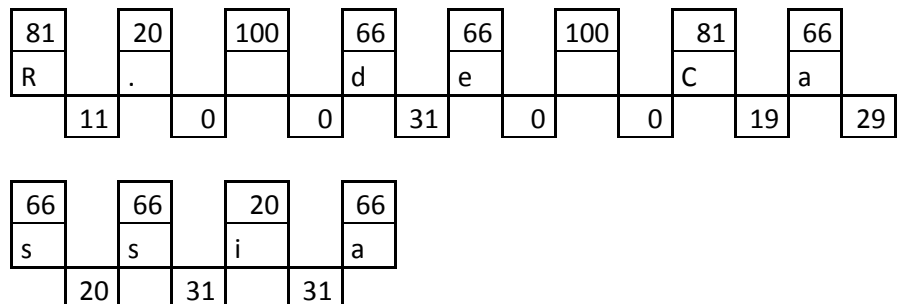

Placa – 43 (Suporte P53m)



Status: Implementar
Dimensões: 2,50m x 0,70m



Tabela de cotas (mm):

a	b	c	d	e	f	g	h	i	j	k	l	m	n	o
110	1493	230	271	112	184,5	1014	74	50	497	32	62	150	64	114

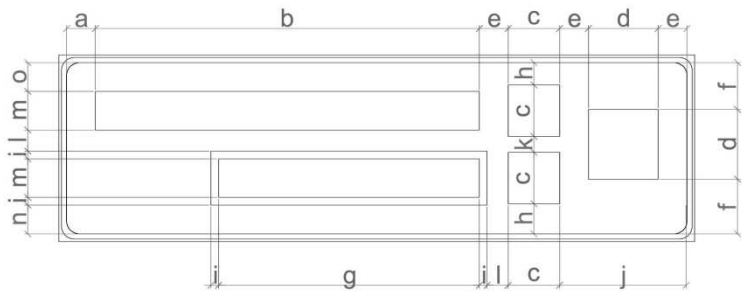

Fundo: Marrom
Tarja: Branco
Letra: Branco
Borda: Marrom
Pictograma: 230mm x 230mm

Seta: Tipo S2 / Cor: Branco



Fundo: Azul
Tarja: Branco
Letra: Branco
Borda: Azul
Pictograma: 230mm x 230mm

Contorno (mm)

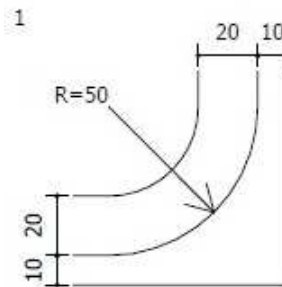

Fonte: Série E(m)

Altura (mm): 150

Cor: Branca

Largura (mm): 1493

122	99	75	75	99	150	30	78	
S	e	r	r	a		l	t	
	33	47	36	23	0	0	44	35

99	99	99	99
a	g	u	á
	47	60	47

Fonte: Série E(m)

Altura (mm): 150

Cor: Branca

Largura (mm): 1014

122	99	165	99	30	99	99
C	a	m	p	i	n	g
	29	60	60	47	60	47

Placa – 44 (Suporte P53m)

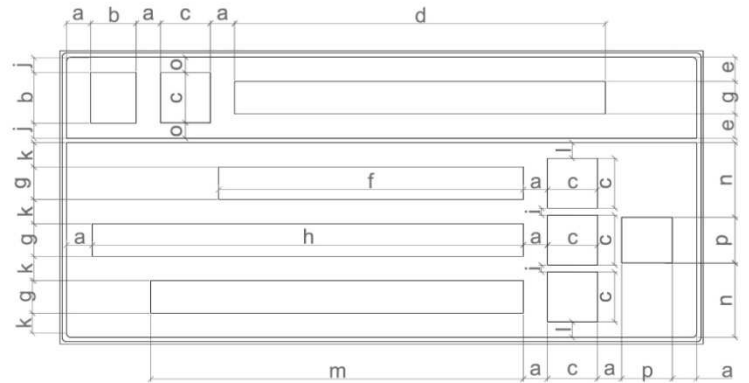

Status: Implementar
Dimensões: 2,90m x 1,40m

Tabela de cotas (mm):

a	b	c	d	e	f	g	h	i	j	k	l	m	n	o	p
104	194	230	1493	112	1296	150	1893	34	90	114	74	1436	348	72	271



Fundo: Marrom
Tarja: Branco
Letra: Branco
Borda: Marrom
Pictograma: 230mm x 230mm

Seta: Tipo S1 / Cor: Branco



Fundo: Marrom
Tarja: Branco
Letra: Branco
Borda: Marrom
Pictograma: 230mm x 230mm

Seta: Tipo S2 / Cor: Branco

Contorno (mm)

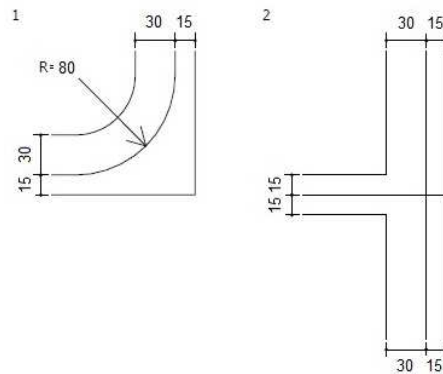

Fonte: Série E(m)
 Altura (mm): 150
 Cor: Branca
 Largura (mm): 1493

122	99	75	75	99	150	30	78
S	e	r	r	a		l	t
	33	47	36	23	0	0	44
							35

99	99	99	99
a	g	u	á
	47	60	47

Fonte: Série E(m)
 Altura (mm): 150
 Cor: Branca
 Largura (mm): 1296

122	99	99	99	102	99	30	75
C	a	c	h	o	e	i	r
	29	47	47	47	33	47	60
							23

99	99
a	s
	44

Fonte: Série E(m)
 Altura (mm): 150
 Cor: Branca
 Largura (mm): 1893

122	30	150	99	99	150	140	99
C	.		d	e		M	e
	18	0	0	47	0	0	38
							33

99	30	78	99	99	99	102
d	i	t	a	ç	ã	o
	60	44	35	47	33	47

Fonte: Série E(m)
 Altura (mm): 150
 Cor: Branca
 Largura (mm): 1436

122	99	30	111	99	102	30	102
P	q	.	E	c	o	l	ó
	23	36	27	27	33	47	47
							33

99	30	99	102
g	i	c	o
	60	47	33

Placa – 45 (Suporte P55)

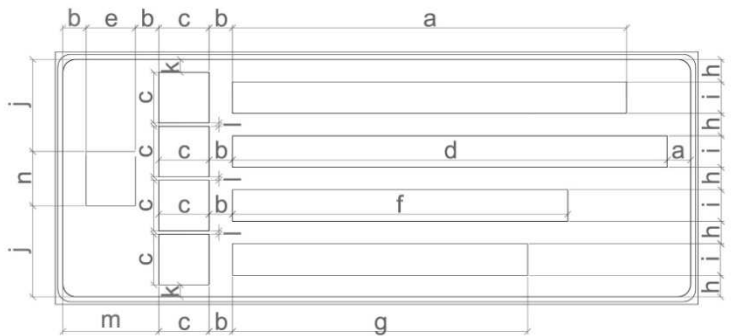

Status: Implementar
Dimensões: 2,60m x 1,00m

Tabela de cotas (mm):

a	b	c	d	e	f	g	h	i	j	k	l	m	n
1643	110	230	1725	175	798	1109	88	125	372,5	50,5	13	395	195



Fundo: Marrom
Tarja: Branco
Letra: Branco
Borda: Marrom
Pictograma: 200mm x 200mm
Seta: Tipo S2 / Cor: Branco

Contorno (mm)

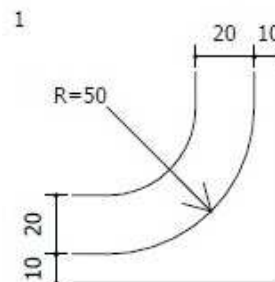

Fonte: Série E(m)
 Altura (mm): 125
 Cor: Branca
 Largura (mm): 1643

101	83	83	65	63	85	125	101	
C	e	n	t	r	o		H	
	24	39	36	40	19	0	0	43

25	83	65	85	63	25	83	85
i	s	t	ó	r	i	c	o
	36	25	29	39	30	39	28

Fonte: Série E(m)
 Altura (mm): 125
 Cor: Branca
 Largura (mm): 1725

93	83	63	25	101	83	83	65	
T	u	r	.	G	a	s	t	
	30	50	10	18	26	36	25	40

63	85	83	85	138	25	83	85
r	o	n	ô	m	i	c	o
	19	39	39	39	50	39	28

Fonte: Série E(m)
 Altura (mm): 125
 Cor: Branca
 Largura (mm): 798

93	83	138	83	25	85	83
T	e	m	p	l	o	s
	19	39	50	39	39	25

Fonte: Série E(m)
 Altura (mm): 125
 Cor: Branca
 Largura (mm): 1109

83	83	85	65	83	63	25	83	
E	c	o	t	u	r	i	s	
	28	28	25	40	50	30	36	39

138	85
m	o
	39

Placa – 46 (Suporte P53m)



Status: Implementar
Dimensões: 3,00m x 1,00m



Tabela de cotas (mm):

a	b	c	d	e	f	g	h	i	j	k	l	m	n
117	957	230	271	1971	83	150	73	50	122	67	42	334,5	1242

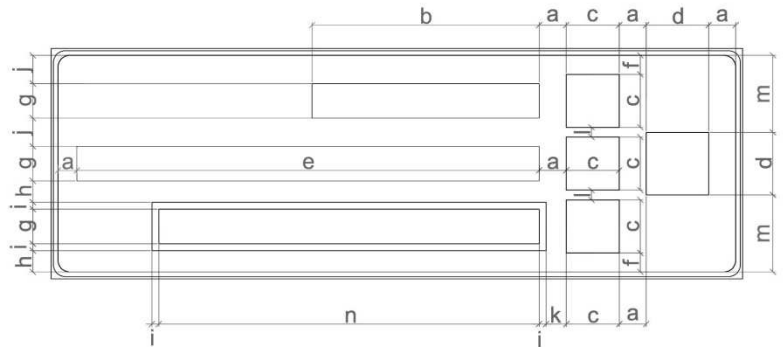

Fundo: Marrom
Tarja: Branco
Letra: Branco
Borda: Marrom
Pictograma: 230mm x 230mm

Seta: Tipo S2 / Cor: Branco



Fundo: Azul
Tarja: Branco
Letra: Branco
Borda: Azul
Pictograma: 230mm x 230mm

Contorno (mm)

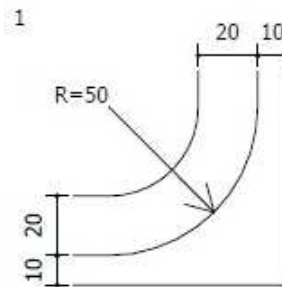

Fonte: Série E(m)
 Altura (mm): 150
 Cor: Branca
 Largura (mm): 957

111	99	165	99	30	102	99
T	e	m	p	l	o	s
	23	47	60	47	47	30

Fonte: Série E(m)
 Altura (mm): 150
 Cor: Branca
 Largura (mm): 1971

122	99	99	78	75	102	150	122
C	e	n	t	r	o		H
	29	47	44	48	23	0	0

30	99	78	102	75	30	99	102
i	s	t	ó	r	i	c	o
	44	30	35	47	36	47	33

Fonte: Série E(m)
 Altura (mm): 150
 Cor: Branca
 Largura (mm): 1242

122	102	99	102	116	30	99	75
R	o	d	o	v	i	á	r
	27	33	47	30	44	47	60

30	99
i	a
	47

Placa – 47 (Suprimida)

Placa – 48 (Suporte P53m)



Status: Implementar
Dimensões: 3,00m x 1,00m

Tabela de cotas (mm):

a	b	c	d	e	f	g	h	i	j	k	l	m
112	271	230	1406	334,5	1707	150	133	32	1997	106	93	495

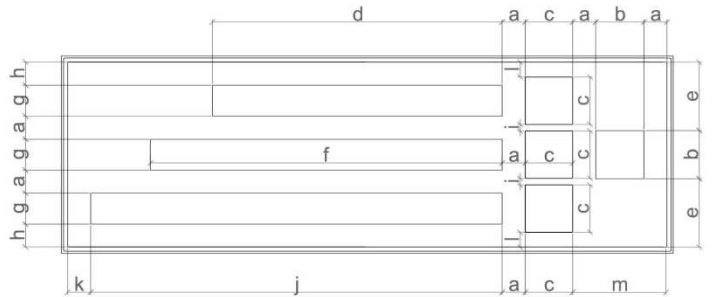

Fundo: Marrom
Tarja: Branco
Letra: Branco
Borda: Marrom
Pictograma: 230mm x 230mm
Seta: Tipo S2 / Cor: Branco

Contorno (mm)

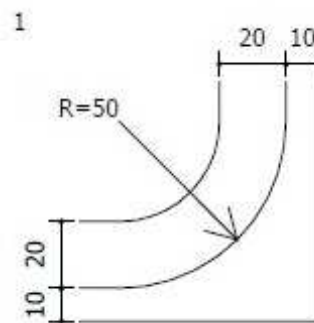

Fonte: Série E(m)
 Altura (mm): 150
 Cor: Branca
 Largura (mm): 1406

122	99	99	120	30	99	99	99
G	u	a	x	i	n	d	u
	45	47	47	47	60	47	60
							44

116	99
v	a
	30

Fonte: Série E(m)
 Altura (mm): 150
 Cor: Branca
 Largura (mm): 1707

122	30	114	30	150	99	102	150
B	.	J	.		d	o	
	18	12	27	0	0	47	0
							0

122	102	99	63	30	165
B	o	n	f	i	m
	29	47	45	47	60

Fonte: Série E(m)
 Altura (mm): 150
 Cor: Branca
 Largura (mm): 1997

122	78	84	30	150	122	30	150
S	t	a	.		R	.	
	30	30	18	0	0	17	0
							0

99	99	150	122	99	99	99	30
d	e		C	a	s	s	i
	47	0	0	29	44	30	47
							47

99
a

Placa – 49 (Suporte P53m)



Status: Implementar
Dimensões: 3,00m x 1,00m



Tabela de cotas (mm):

a	b	c	d	e	f	g	h	i	j	k	l	m	n
112	234	230	1406	210	1707	150	133	32	1997	143	93	458	365

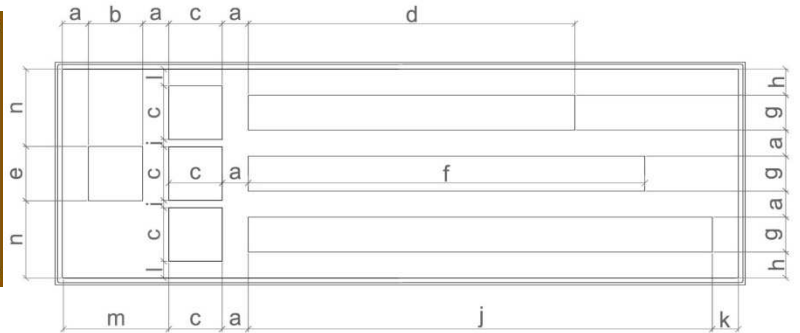
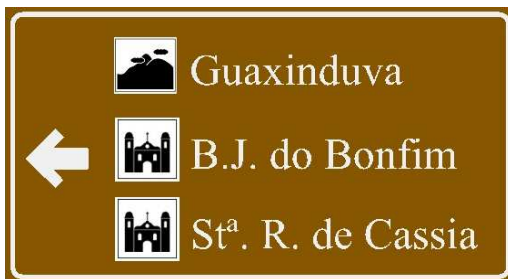

Fundo: Marrom
Tarja: Branco
Letra: Branco
Borda: Marrom
Pictograma: 230mm x 230mm
Seta: Tipo S3 / Cor: Branco

Contorno (mm)

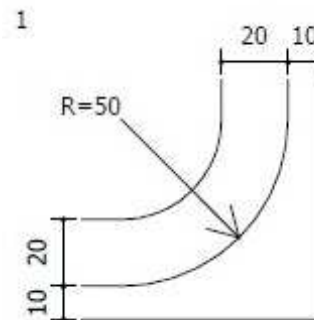

Fonte: Série E(m)
 Altura (mm): 150
 Cor: Branca
 Largura (mm): 1406

122	99	99	120	30	99	99	99
G	u	a	x	i	n	d	u
	45	47	47	47	60	47	60
							44

116	99
v	a
	30

Fonte: Série E(m)
 Altura (mm): 150
 Cor: Branca
 Largura (mm): 1707

122	30	114	30	150	99	102	150
B	.	J	.		d	o	
	18	12	27	0	0	47	0
							0

122	102	99	63	30	165
B	o	n	f	i	m
	29	47	45	47	60

Fonte: Série E(m)
 Altura (mm): 150
 Cor: Branca
 Largura (mm): 1997

122	78	84	30	150	122	30	150
S	t	a	.		R	.	
	30	30	18	0	0	17	0
							0

99	99	150	122	99	99	99	30
d	e		C	a	s	s	i
	47	0	0	29	44	30	47
							47

99
a

Placa – 50 (Suporte P53m)



Status: Implementar
Dimensões: 3,00m x 1,40m



Tabela de cotas (mm):

a	b	c	d	e	f	g	h	i	j	k	l	m	n	o	p
112	1997	230	234	113	1707	150	1406	34	70	114	74	1493	348	72	210

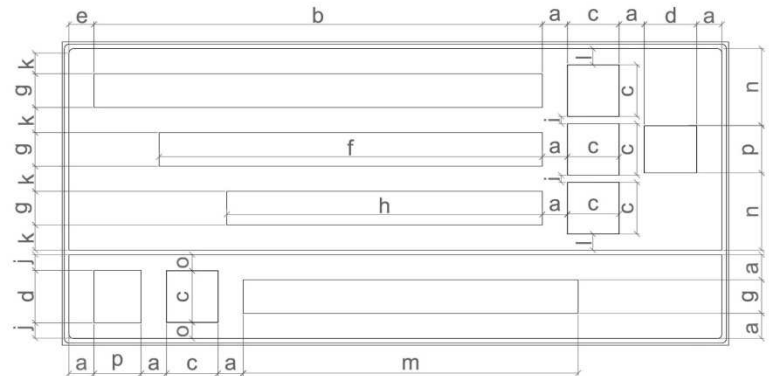

Fundo: Marrom
Tarja: Branco
Letra: Branco
Borda: Marrom
Pictograma: 230mm x 230mm

Seta: Tipo S3 / Cor: Branco



Fundo: Marrom
Tarja: Branco
Letra: Branco
Borda: Marrom
Pictograma: 230mm x 230mm

Seta: Tipo S1 / Cor: Branco

Contorno (mm)

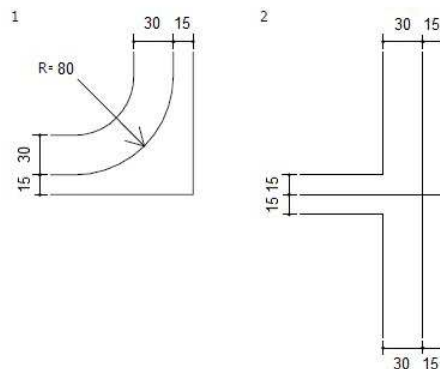

Fonte: Série E(m)
 Altura (mm): 150
 Cor: Branca
 Largura (mm): 1997

122	78	84	30	150	122	30	150
S	t	a	.		R	.	
	30	30	18	0	0	17	0
99	99	150	122	99	99	99	30
d	e		C	a	s	s	i
	47	0	0	29	44	30	47
99							
a							

Fonte: Série E(m)
 Altura (mm): 150
 Cor: Branca
 Largura (mm): 1707

122	30	114	30	150	99	102	150
B	.	J	.		d	o	
	18	12	27	0	0	47	0
122	102	99	63	30	165		
B	o	n	f	i	m		
	29	47	45	47	60		

Fonte: Série E(m)
 Altura (mm): 150
 Cor: Branca
 Largura (mm): 1406

122	99	99	120	30	99	99	99
G	u	a	x	i	n	d	u
	45	47	47	47	60	47	60
116	99						
v	a						
	30						

Fonte: Série E(m)
 Altura (mm): 150
 Cor: Branca
 Largura (mm): 1493

122	99	75	75	99	150	30	78
S	e	r	r	a		l	t
	33	47	36	23	0	0	44
99	99	99	99				
a	g	u	á				
	47	60	47				

Placa – 51 (Suporte P55)

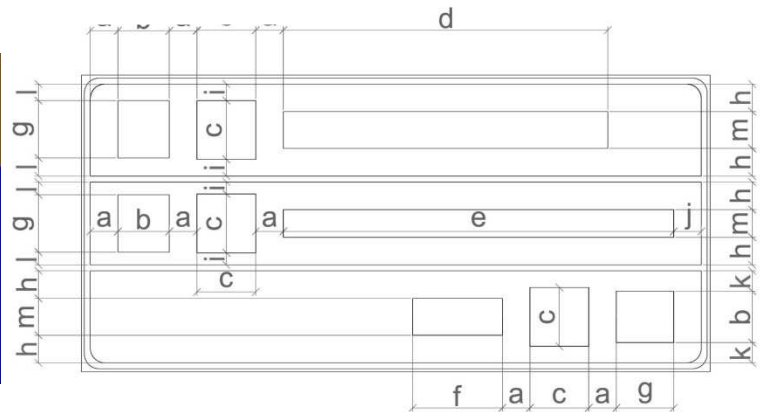
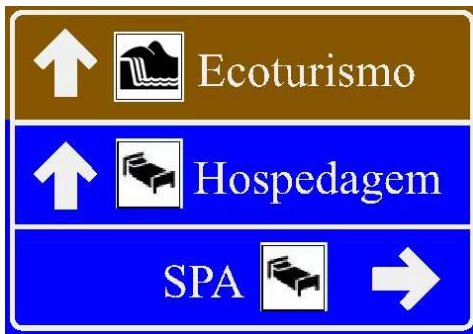

Status: Implementar
Dimensões: 2,15m x 1,00m

Tabela de cotas (mm):

a	b	c	d	e	f	g	h	i	j	k	l	m
97	175	200	1109	1328	305	195	87,5	50	96	62,5	52,5	125



Fundo: Marrom
Tarja: Branco
Letra: Branco
Borda: Marrom
Pictograma: 200mm x 200mm

Seta: Tipo S1 / Cor: Branco



Fundo: Azul
Tarja: Branco
Letra: Branco
Borda: Azul
Pictograma: 200mm x 200mm

Seta: Tipo S1 / Cor: Branco



Fundo: Azul
Tarja: Branco
Letra: Branco
Borda: Azul
Pictograma: 200mm x 200mm

Seta: Tipo S1 / Cor: Branco

Contorno (mm)

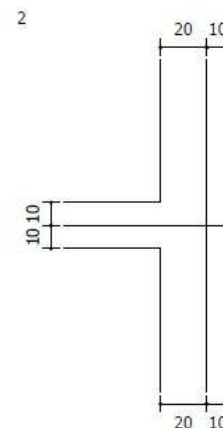
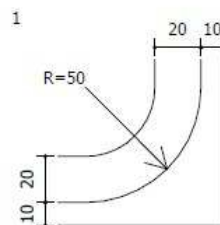

Fonte: Série E(m)

Altura (mm): 125

Cor: Branca

Largura (mm): 1109

83	83	85	65	83	63	25	83	
E	c	o	t	u	r	i	s	
	28	28	25	40	50	30	36	39

138	85
m	o
	39

Fonte: Série E(m)

Altura (mm): 125

Cor: Branca

Largura (mm): 1328

101	85	83	83	83	83	83	83	
H	o	s	p	e	d	a	g	
	31	25	39	28	28	39	39	39

83	83	138
g	e	m
	39	39

Fonte: Série D

Altura (mm): 125

Cor: Branca

Largura (mm): 305

85	85	106
S	P	A
	21	8

Placa – 52 e 55 (Suporte P55)

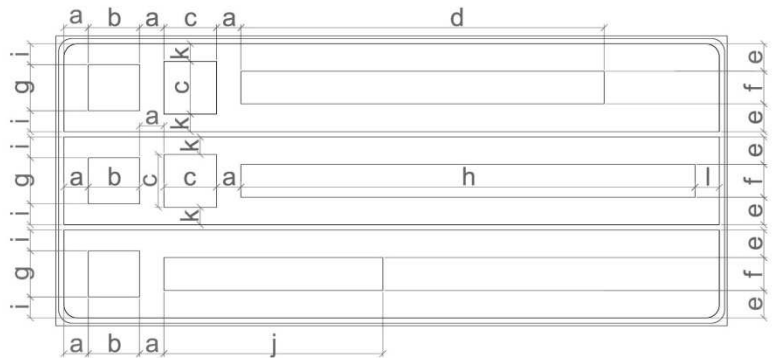

Status: Implementar
Dimensões: 2,15m x 1,00m

Tabela de cotas (mm):

a	b	c	d	e	f	g	h	i	j	k	l
92	195	200	1109	87,5	125	175	1328	62,5	712	50	91



Fundo: Marrom
Tarja: Branco
Letra: Branco
Borda: Marrom
Pictograma: 200mm x 200mm

Seta: Tipo S1 / Cor: Branco



Fundo: Azul
Tarja: Branco
Letra: Branco
Borda: Azul
Pictograma: 200mm x 200mm

Seta: Tipo S1 / Cor: Branco



Fundo: Verde
Tarja: Branco
Letra: Branco
Borda: Verde

Seta: Tipo S1 / Cor: Branco

Contorno (mm)

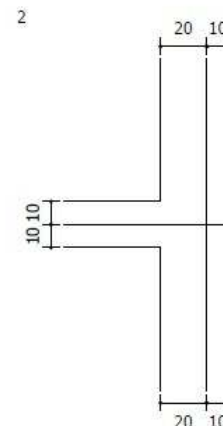
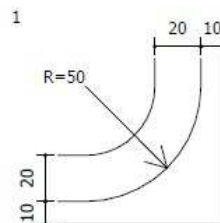

Fonte: Série E(m)
 Altura (mm): 125
 Cor: Branca
 Largura (mm): 1109

83	83	85	65	83	63	25	83	
E	c	o	t	u	r	i	s	
	28	28	25	40	50	30	36	39

138	85
m	o
	39

Fonte: Série E(m)
 Altura (mm): 125
 Cor: Branca
 Largura (mm): 1328

101	85	83	83	83	83	83	83	
H	o	s	p	e	d	a	g	
	31	25	39	28	28	39	39	39

83	83	138
g	e	m
	39	39

Fonte: Série D
 Altura (mm): 125
 Cor: Branca
 Largura (mm): 712

85	78	78	89	85	85	89
R	E	T	O	R	N	O
	21	10	16	28	21	28

Placa – 53 (Suporte P53m)

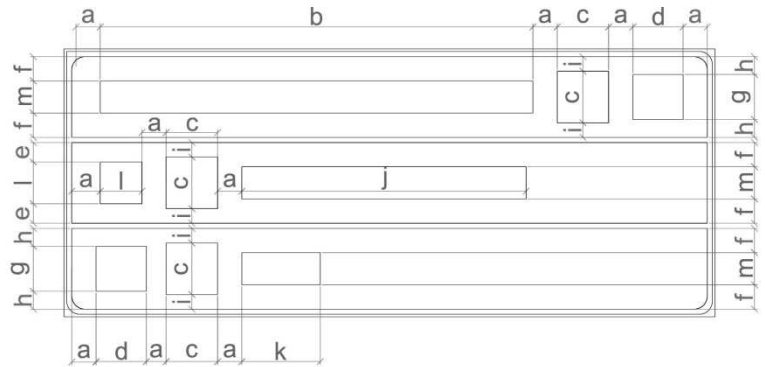

Status: Implementar
Dimensões: 2,50m x 1,00

Tabela de cotas (mm):

a	b	c	d	e	f	g	h	i	j	k	l	m
91	1681	200	195	69	87,5	175	62,5	50	1109	305	162	125



Fundo: Marrom
Tarja: Branco
Letra: Branco
Borda: Marrom
Pictograma: 200mm x 200mm

Seta: Tipo S1 / Cor: Branco



Fundo: Marrom
Tarja: Branco
Letra: Branco
Borda: Marrom
Pictograma: 200mm x 200mm

Seta: Tipo S1 / Cor: Branco



Fundo: Azul
Tarja: Branco
Letra: Branco
Borda: Azul

Pictograma: 200mm x 200mm

Seta: Tipo S1 / Cor: Branco

Contorno (mm)

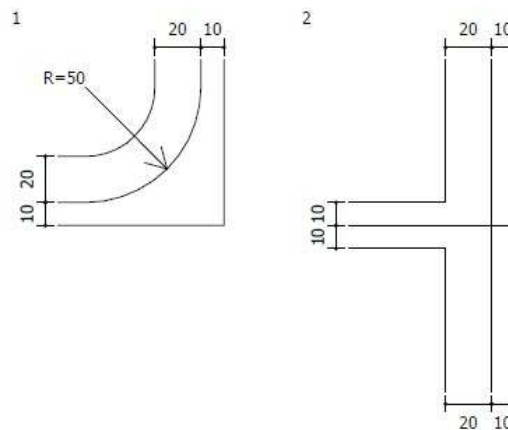

Fonte: Série E(m)

Altura (mm): 125

Cor: Branca

Largura (mm): 1681

116	85	83	65	83	25	63	85	
M	o	s	t	e	i	r	o	
	31		25		29		39	
		25		29		39		50
			35		39		50	
				39		50		36
					50		36	
						25		29
							25	
								29

Fonte: Série E(m)

Altura (mm): 125

Cor: Branca

Largura (mm): 1109

83	83	85	65	83	63	25	83	
E	c	o	t	u	r	i	s	
	28		28		25		40	
		28		25		40		50
			28		25		40	
				25		40		50
					25		40	
						25		40
							25	
								40

Fonte: Série D

Altura (mm): 125

Cor: Branca

Largura (mm): 305

85	85	106	
S	P	A	
	21		8

Placa – 54 (Suporte P57)

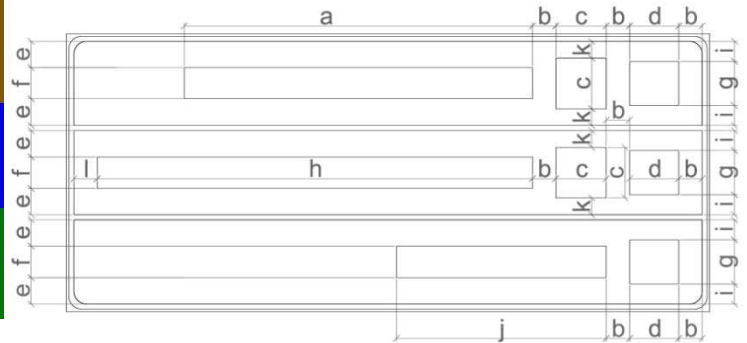

Status: Implementar
Dimensões: 2,15m x 1,00m

Tabela de cotas (mm):

a	b	c	d	e	f	g	h	i	j	k	l
1109	92	200	195	87,5	125	175	1328	62,5	712	50	91



Fundo: Marrom
Tarja: Branco
Letra: Branco
Borda: Marrom
Pictograma: 200mm x 200mm

Seta: Tipo S1 / Cor: Branco



Fundo: Azul
Tarja: Branco
Letra: Branco
Borda: Azul
Pictograma: 200mm x 200mm

Seta: Tipo S1 / Cor: Branco



Fundo: Verde
Tarja: Branco
Letra: Branco
Borda: Verde

Seta: Tipo S1 / Cor: Branco

Contorno (mm)

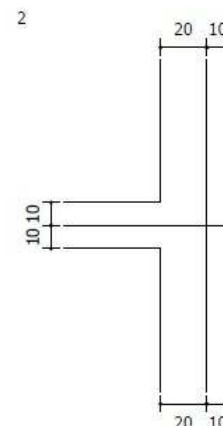
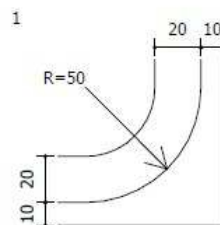

Fonte: Série E(m)
 Altura (mm): 125
 Cor: Branca
 Largura (mm): 1109

83		83		85		65		83		63		25		83
E		c		o		t		u		r		i		s
	28		28		25		40		50		30		36	39

138		85
m		o
	39	

Fonte: Série E(m)
 Altura (mm): 125
 Cor: Branca
 Largura (mm): 1328

101		85		83		83		83		83		83		83
H		o		s		p		e		d		a		g
	31		25		39		28		28		39		39	39

83		83		138
g		e		m
	39		39	

Fonte: Série D
 Altura (mm): 125
 Cor: Branca
 Largura (mm): 712

85		78		78		89		85		85		89
R		E		T		O		R		N		O
	21		10		16		28		21		28	

Placa – 56 (Suporte P55)

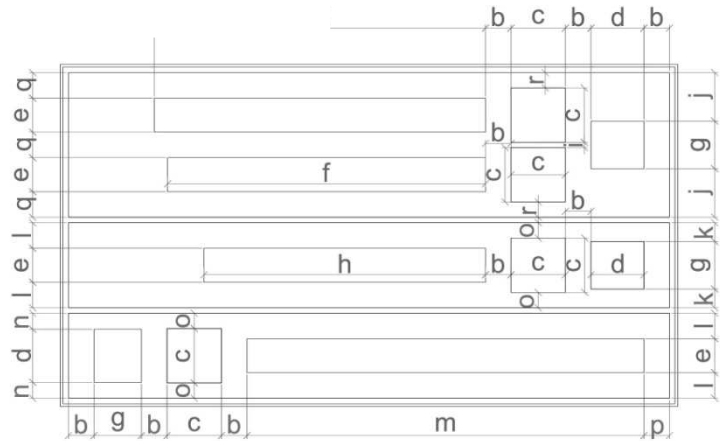

Status: Implementar
Dimensões: 2,25m x 1,25m

Tabela de cotas (mm):

a	b	c	d	e	f	g	h	i	j	k	l	m	n	o	p	q	r
1218	90	200	195	125	1169	175	1035	19	178,5	67	92	1460	57	54,5	85	94	56,5

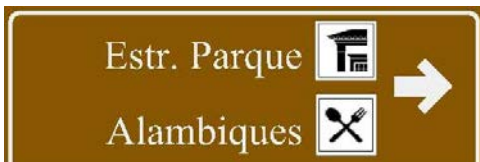

Fundo: Marrom
Tarja: Branco
Letra: Branco
Borda: Marrom
Pictograma: 200mm x 200mm

Seta: Tipo S3 / Cor: Branco



Fundo: Azul
Tarja: Branco
Letra: Branco
Borda: Azul
Pictograma: 200mm x 200mm

Seta: Tipo S1 / Cor: Branco



Fundo: Azul
Tarja: Branco
Letra: Branco
Borda: Azul
Pictograma: 200mm x 200mm

Seta: Tipo S1 / Cor: Branco

Contorno (mm)

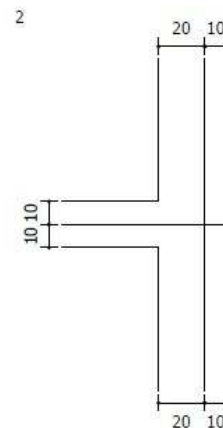
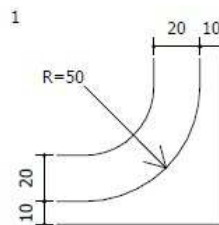

Fonte: Série E(m)
 Altura (mm): 125
 Cor: Branca
 Largura (mm): 1218

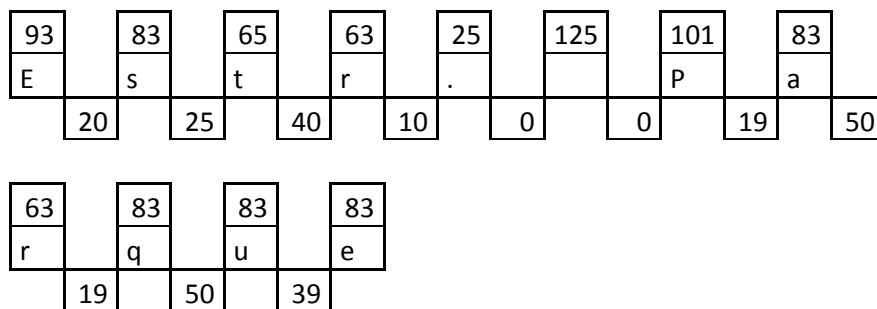

Fonte: Série E(m)
 Altura (mm): 125
 Cor: Branca
 Largura (mm): 1169

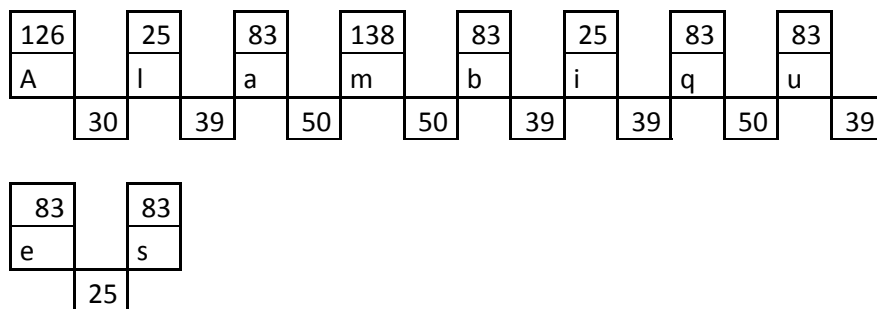

Fonte: Série E(m)
 Altura (mm): 125
 Cor: Branca
 Largura (mm): 1035

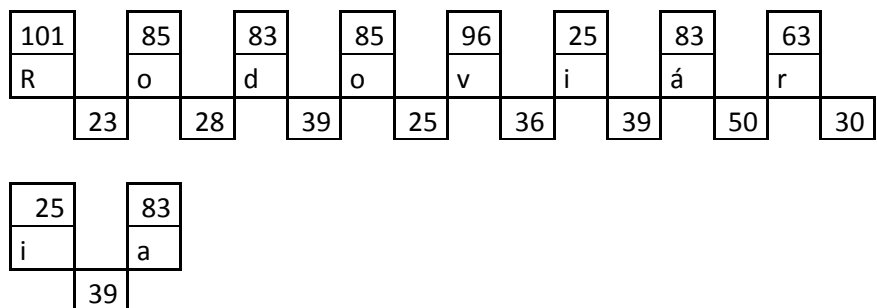

Fonte: Série E(m)
 Altura (mm): 125
 Cor: Branca
 Largura (mm): 1460

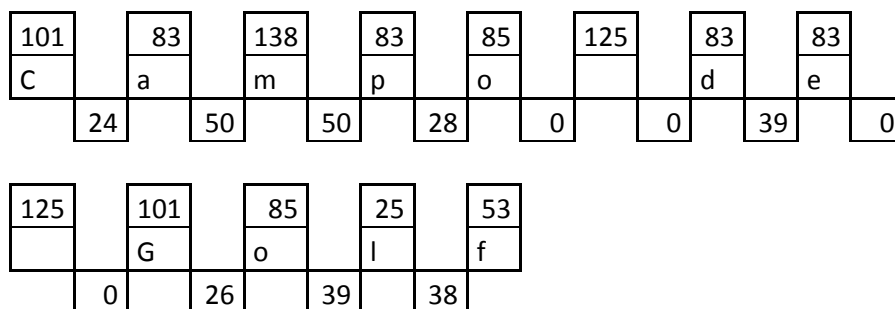

Placa – 57 e 73 (Suporte placa 57 - P57 e Placa 73 – P55)

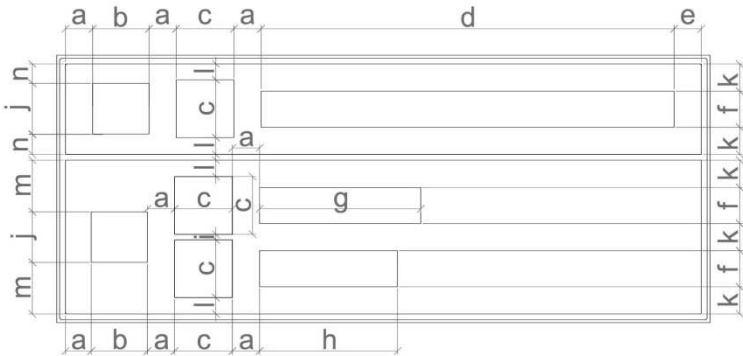

Status: Implementar
Dimensões: 2,50m x 0,90m

Tabela de cotas (mm):

a	b	c	d	e	f	g	h	i	j	k	l	m	n
96	195	200	1660	97	125	483	305	14	175	89	51,5	171	64



Fundo: Marrom
Tarja: Branco
Letra: Branco
Borda: Marrom
Pictograma: 200mm x 200mm

Seta: Tipo S1 / Cor: Branco



Fundo: Azul
Tarja: Branco
Letra: Branco
Borda: Azul
Pictograma: 200mm x 200mm

Seta: Tipo S3 / Cor: Branco

Contorno (mm)

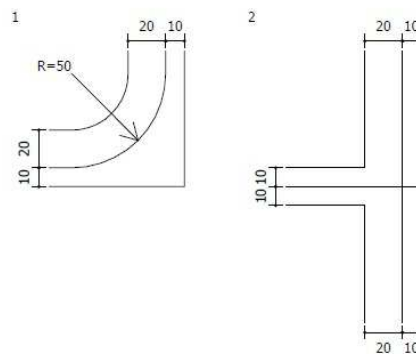

Fonte: Série E(m)

Altura (mm): 125

Cor: Branca

Largura (mm): 1660

93	83	63	25	125	83	83	125	
T	u	r	.		d	e		
	30	50	10	0	0	39	0	0

101	83	83	85	83	25	85	83
N	e	g	ó	c	i	o	s
	31	28	39	28	39	39	25

Fonte: Série E(m)

Altura (mm): 125

Cor: Branca

Largura (mm): 483

101	85	65	83	25
H	o	t	e	l
	31	25	29	39

Fonte: Série D

Altura (mm): 125

Cor: Branca

Largura (mm): 305

85	85	106
S	P	A
	21	8

Placa – 58 (Suporte P55)



Status: Implementar
Dimensões: 2,70m x 1,25m



Tabela de cotas (mm):

a	b	c	d	e	f	g	h	i	j	k	l	m	n	o	p	q	r
95	175	200	1738	1526	1864	845	195	19	92	125	54,5	178,5	57	94	56,5	96	67

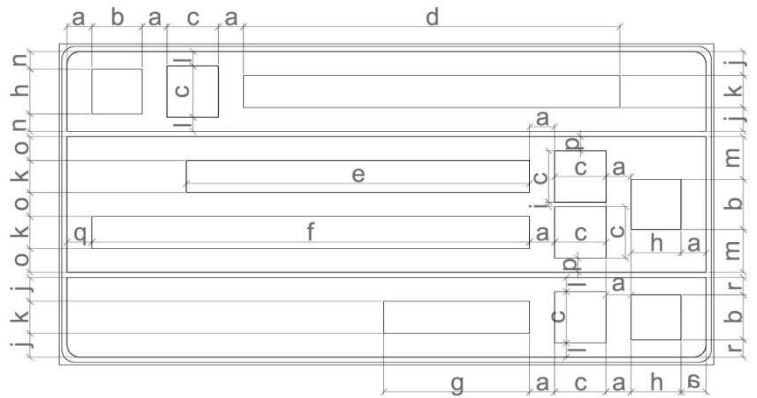

Fundo: Marrom
Tarja: Branco
Letra: Branco
Borda: Marrom
Pictograma: 200mm x 200mm

Seta: Tipo S1 / Cor: Branco

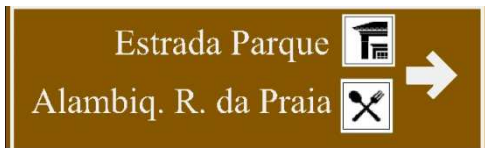

Fundo: Marrom
Tarja: Branco
Letra: Branco
Borda: Marrom
Pictograma: 200mm x 200mm

Seta: Tipo S3 / Cor: Branco



Fundo: Azul
Tarja: Branco
Letra: Branco
Borda: Azul
Pictograma: 200mm x 200mm

Seta: Tipo S1 / Cor: Branco

Contorno (mm)

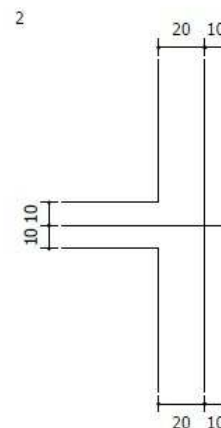
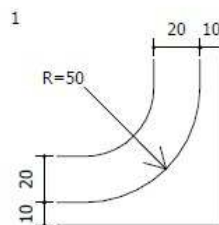

Fonte: Série E(m)
 Altura (mm): 125
 Cor: Branca
 Largura (mm): 1738

126	25	83	138	83	25	83	83
A	l	a	m	b	i	q	u
	30	39	50	50	39	39	50
83	125	115	25	25	83	25	83
e		v	i	l	e	l	a
	0	0	30	50	39	39	39

Fonte: Série E(m)
 Altura (mm): 125
 Cor: Branca
 Largura (mm): 1526

93	83	65	63	83	83	83	125
E	s	t	r	a	d	a	
	20	25	40	19	39	39	0
101	83	63	83	83	83		
P	a	r	q	u	e		
	19	50	19	50	39		

Fonte: Série E(m)
 Altura (mm): 125
 Cor: Branca
 Largura (mm): 1864

126	25	83	138	83	25	83	25
A	l	a	m	b	i	q	.
	30	39	50	50	39	39	30
101	25	83	83	125	101	63	83
R	.	d	a		P	r	a
	14	19	39	0	0	30	19
25	83						
i	a						
	39						

Fonte: Série E(m)
 Altura (mm): 125
 Cor: Branca
 Largura (mm): 845

101	83	138	83	25	83	83
C	a	m	p	l	n	g
	24	50	50	39	50	39

Placa – 59 (Centralizada em pórtico existente)

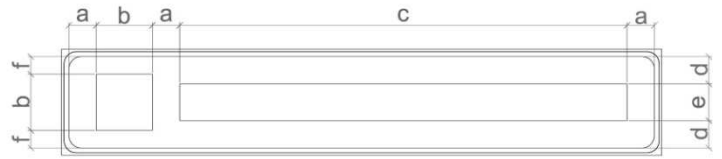

Status: Implementar
Dimensões: 2,50m x 0,40m

Tabela de cotas (mm):

a	b	c	d	e	f
126	230	1832	95	150	55



Fundo: Marrom
Talha: Branco
Letra: Branco
Borda: Marrom
Pictograma: 230mm x 230mm

Contorno (mm)

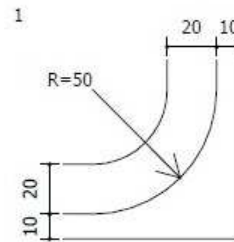

Fonte: Série E(m)

Altura (mm): 150

Cor: Branca

Largura (mm): 1832

111	99	78	75	99	99	99	150
E	s	t	r	a	d	a	
	24	30	48	23	47	47	0

122	99	75	99	99	99
P	a	r	q	u	e
	23	60	23	60	47

Placa – 60 e 67 (Suporte P55)

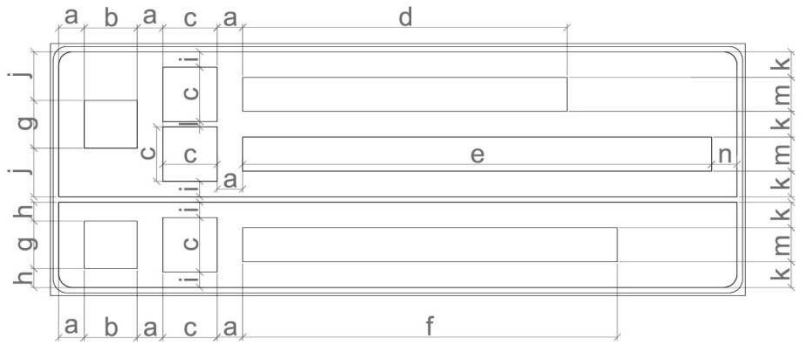

Status: Implementar
Dimensões: 2,50m x 0,90m

Tabela de cotas (mm):

a	b	c	d	e	f	g	h	i	j	k	l	m	n
96	195	200	1061	1660	1206	175	64	51,5	171	89	14	125	97



Fundo: Marrom
Tarja: Branco
Letra: Branco
Borda: Marrom
Pictograma: 200mm x 200mm

Seta: Tipo S3 / Cor: Branco



Fundo: Azul
Tarja: Branco
Letra: Branco
Borda: Azul
Pictograma: 200mm x 200mm

Seta: Tipo S1 / Cor: Branco

Contorno (mm)

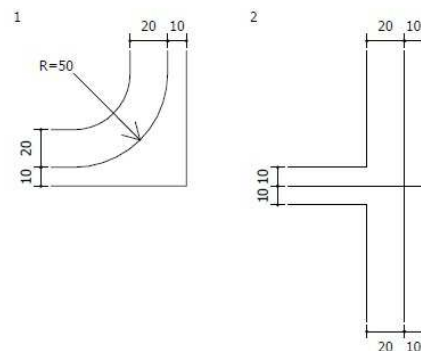

Fonte: Série E(m)

Altura (mm): 125

Cor: Branca

Largura (mm): 1061

126	25	83	138	83	25	83	83	
A	l	a	m	b	i	q	u	
	30	39	50	50	39	39	50	39

83
e

Fonte: Série E(m)

Altura (mm): 125

Cor: Branca

Largura (mm): 1660

93	83	63	25	125	83	83	125	
T	u	r	.		d	e		
	30	50	10	0	0	39	0	0

101	83	83	85	83	25	85	83
N	e	g	ó	c	i	o	s
	31	28	39	28	39	39	25

Fonte: Série E(m)

Altura (mm): 125

Cor: Branca

Largura (mm): 1206

101	85	83	83	83	83	83	83	
H	o	s	p	e	d	a	g	
	31	25	39	28	28	39	39	39

83	83	138
g	e	m
	39	39

Placa – 61 (Suporte P55)

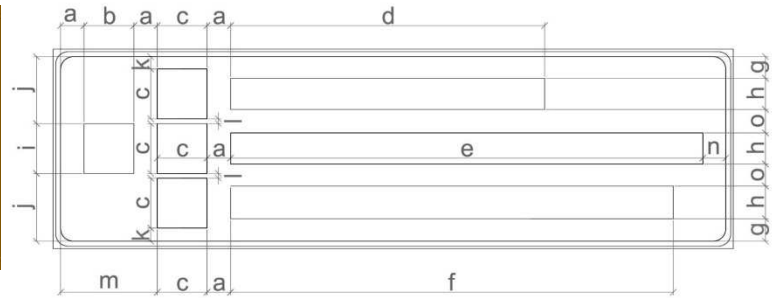

Status: Implementar
 Dimensões: 2,55m x 0,80m

Tabela de cotas (mm):

a	b	C	d	e	f	g	h	i	j	k	l	m	n	o
93	195	200	1061	1725	1643	90,5	125	175	282,5	53	17	371	91	92



Fundo: Marrom
 Tarja: Branco
 Letra: Branco
 Borda: Marrom
 Pictograma: 200mm x 200mm

Seta: Tipo S3 / Cor: Branco

Contorno (mm)

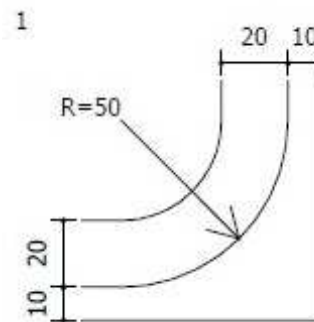

Fonte: Série E(m)

Altura (mm): 125

Cor: Branca

Largura (mm): 1061

126	25	83	138	83	25	83	83	
A	l	a	m	b	i	q	u	
	30	39	50	50	39	39	50	39
83								
e								

Fonte: Série E(m)

Altura (mm): 125

Cor: Branca

Largura (mm): 1725

93	83	63	25	101	83	83	65	
T	u	r	.	G	a	s	t	
	30	50	10	18	26	36	25	40
63	85	83	85	138	25	83	85	
r	o	n	ô	m	i	c	o	
	19	39	39	39	50	39	28	

Fonte: Série E(m)

Altura (mm): 125

Cor: Branca

Largura (mm): 1643

101	83	83	65	63	85	125	101	
C	e	n	t	r	o		H	
	24	39	36	40	19	0	0	43
25	83	65	85	63	25	83	85	
i	s	t	ó	r	i	c	o	
	36	25	29	39	30	39	28	

Placa – 62 (Suporte P57)

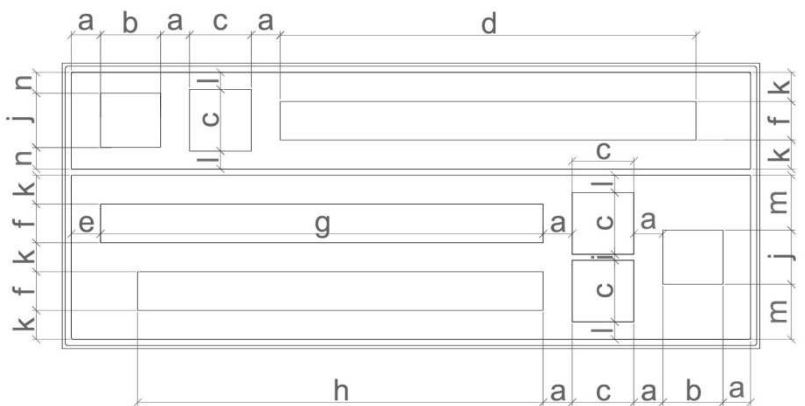

Status: Implementar
Dimensões: 2,55m x 0,90m

Tabela de cotas (mm):

a	b	c	d	e	f	g	h	i	j	k	l	m	n
93	195	200	1660	91	125	1725	1643	14	175	89	51,5	171	64



Fundo: Marrom
Tarja: Branco
Letra: Branco
Borda: Marrom
Pictograma: 200mm x 200mm

Seta: Tipo S1 / Cor: Branco



Fundo: Marrom
Tarja: Branco
Letra: Marrom
Borda: Azul
Pictograma: 200mm x 200mm

Seta: Tipo S3 / Cor: Branco

Contorno (mm)

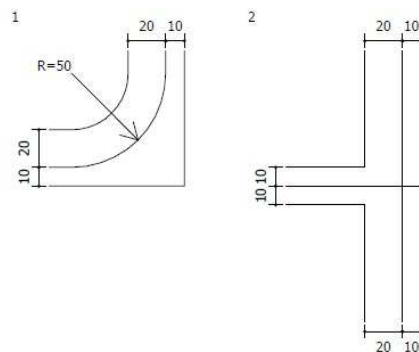

Fonte: Série E(m)
 Altura (mm): 125
 Cor: Branca
 Largura (mm): 1660

93	83	63	25	125	83	83	125
T	u	r	.		d	e	
	30	50	10	0	0	39	0

101	83	83	85	83	25	85	83
N	e	g	ó	c	i	o	s
	31	28	39	28	39	39	25

Fonte: Série E(m)
 Altura (mm): 125
 Cor: Branca
 Largura (mm): 1725

93	83	63	25	101	83	83	65
T	u	r	.	G	a	s	t
	30	50	10	18	26	36	25

63	85	83	85	138	25	83	85
r	o	n	ô	m	i	c	o
	19	39	39	39	50	39	28

Fonte: Série E(m)
 Altura (mm): 125
 Cor: Branca
 Largura (mm): 1643

101	83	83	65	63	85	125	101
C	e	n	t	r	o		H
	24	39	36	40	19	0	0

25	83	65	85	63	25	83	85
i	s	t	ó	r	i	c	o
	36	25	29	39	30	39	28

Placa – 63 (Suporte P55)



Status: Implementar
Dimensões: 2,55m x 0,90m



Tabela de cotas (mm):

a	b	c	d	e	f	g	h	i	j	k	l	m	n
1061	93	200	195	91	125	1725	1643	14	175	89	51,5	161	64

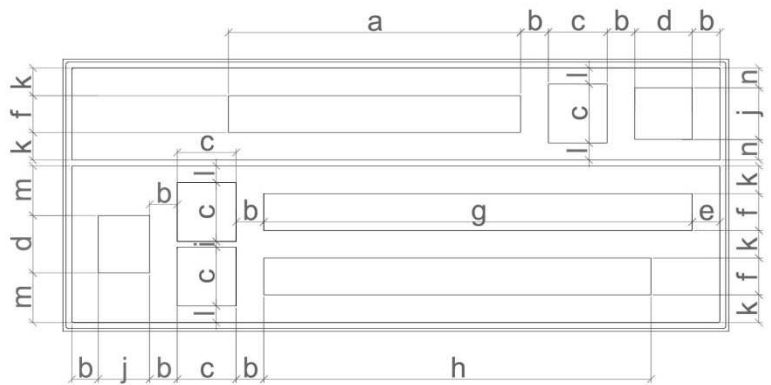

Fundo: Marrom
Tarja: Branco
Letra: Branco
Borda: Marrom
Pictograma: 200mm x 200mm

Seta: Tipo S1 / Cor: Branco



Fundo: Marrom
Tarja: Branco
Letra: Marrom
Borda: Azul
Pictograma: 200mm x 200mm

Seta: Tipo S2 / Cor: Branco

Contorno (mm)

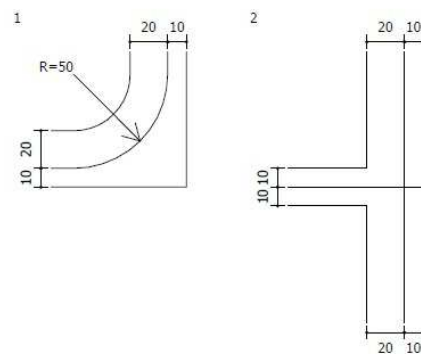

Fonte: Série E(m)

Altura (mm): 125

Cor: Branca

Largura (mm): 1061

126	25	83	138	83	25	83	83	
A	l	a	m	b	i	q	u	
	30	39	50	50	39	39	50	39

83
e

Fonte: Série E(m)

Altura (mm): 125

Cor: Branca

Largura (mm): 1725

93	83	63	25	101	83	83	65	
T	u	r	.	G	a	s	t	
	30	50	10	18	26	36	25	40

63	85	83	85	138	25	83	85
r	o	n	ô	m	i	c	o
	19	39	39	39	50	39	28

Fonte: Série E(m)

Altura (mm): 125

Cor: Branca

Largura (mm): 1643

101	83	83	65	63	85	125	101	
C	e	n	t	r	o		H	
	24	39	36	40	19	0	0	43

25	83	65	85	63	25	83	85
i	s	t	ó	r	i	c	o
	36	25	29	39	30	39	28

Placa – 65 (Suporte P55)

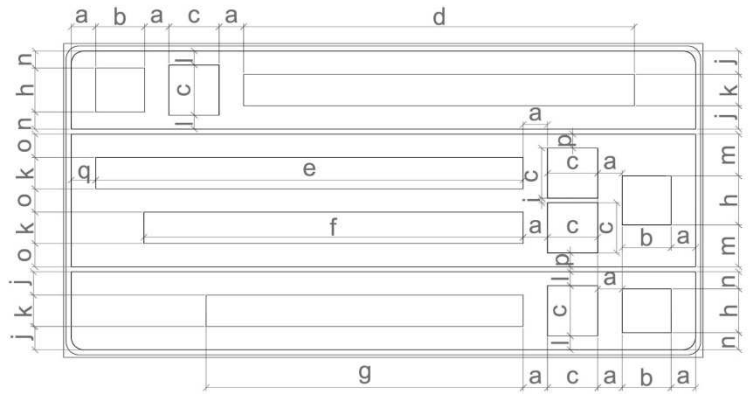

Status: Implementar
Dimensões: 2,70m x 1,25m

Tabela de cotas (mm):

a	b	c	d	e	f	g	h	i	j	k	l	m	n	o	p	q
95	195	200	1738	1864	1660	1328	175	19	92	125	54,5	178,5	67	94	56,5	96



Fundo: Marrom
Tarja: Branco
Letra: Branco
Borda: Marrom
Pictograma: 200mm x 200mm

Seta: Tipo S1 / Cor: Branco

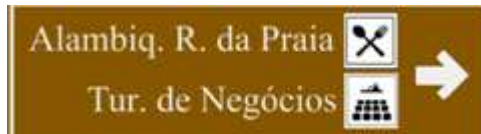

Fundo: Marrom
Tarja: Branco
Letra: Branco
Borda: Marrom
Pictograma: 200mm x 200mm

Seta: Tipo S3 / Cor: Branco



Fundo: Azul
Tarja: Branco
Letra: Branco
Borda: Azul
Pictograma: 200mm x 200mm

Seta: Tipo S1 / Cor: Branco

Contorno (mm)

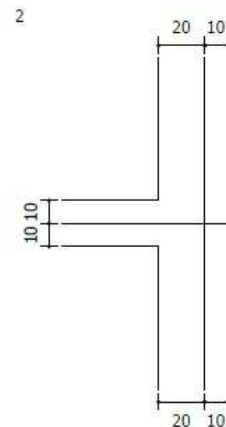
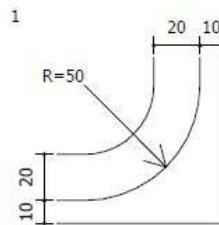

Fonte: Série E(m)
 Altura (mm): 125
 Cor: Branca
 Largura (mm): 1738

126	25	83	138	83	25	83	83
A	l	a	m	b	i	q	u
30	39	50	50	39	39	50	39

83	125	115	25	25	83	25	83
e		v	i	l	e	l	a
0	0	30	50	39	39	39	

Fonte: Série E(m)
 Altura (mm): 125
 Cor: Branca
 Largura (mm): 1864

126	25	83	138	83	25	83	25
A	l	a	m	b	i	q	.
30	39	50	50	39	39	30	23

101	25	83	83	125	101	63	83
R	.	d	a		P	r	a
14	19	39	0	0	30	19	50

25	83
i	a
39	

Fonte: Série E(m)
 Altura (mm): 125
 Cor: Branca
 Largura (mm): 1660

93	83	63	25	125	83	83	125
T	u	r	.		d	e	
30	50	10	0	0	39	0	0

101	83	83	85	83	25	85	83
N	e	g	ó	c	i	o	s
31	28	39	28	39	39	25	

Fonte: Série E(m)
 Altura (mm): 125
 Cor: Branca
 Largura (mm): 1328

101	85	83	83	83	83	83	83
H	o	s	p	e	d	a	g
31	25	39	28	28	39	39	39

83	83	138
g	e	m
39	39	

Placa – 66 (Suporte P55)

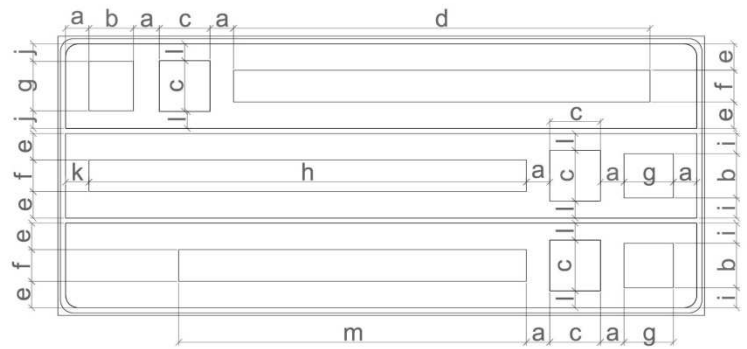

Status: Implementar
Dimensões: 2,50m x 1,00m

Tabela de cotas (mm):

a	b	c	d	e	f	g	h	i	j	k	l	m
96	175	200	845	87,5	125	195	1660	62,5	52,5	97	50	483



Fundo: Azul
Tarja: Branco
Letra: Branco
Borda: Azul
Pictograma: 200mm x 200mm

Seta: Tipo S1 / Cor: Branco



Fundo: Marrom
Tarja: Branco
Letra: Branco
Borda: Marrom
Pictograma: 200mm x 200mm

Seta: Tipo S1 / Cor: Branco



Fundo: Azul
Tarja: Branco
Letra: Branco
Borda: Azul
Pictograma: 200mm x 200mm

Seta: Tipo S1 / Cor: Branco

Contorno (mm)

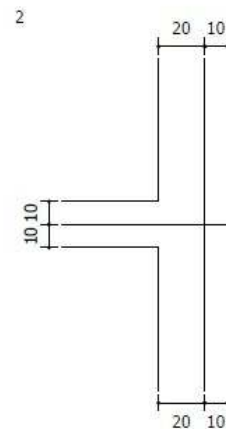
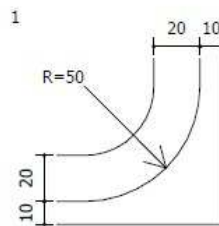

Fonte: Série E(m)
 Altura (mm): 125
 Cor: Branca
 Largura (mm): 845

101	83	138	83	25	83	83
C	a	m	p	l	n	g
	24	50	50	39	50	39

Fonte: Série E(m)
 Altura (mm): 125
 Cor: Branca
 Largura (mm): 1660

93	83	63	25	125	83	83	125
T	u	r	.		d	e	
	30	50	10	0	0	39	0

Fonte: Série E(m)
 Altura (mm): 125
 Cor: Branca
 Largura (mm): 483

101	83	83	85	83	25	85	83
N	e	g	ó	c	i	o	s
	31	28	39	28	39	39	25

Placa – 68 (Suporte P55)



Status: Implementar
Dimensões: 2,55m x 1,00m

Tabela de cotas (mm):

a	b	c	d	e	f	g	h	i	j	k	l	m	n	o	p	q
1141	93	200	195	125	382,5	175	50,5	13	119,5	157	91	1080	1643	1725	361	88

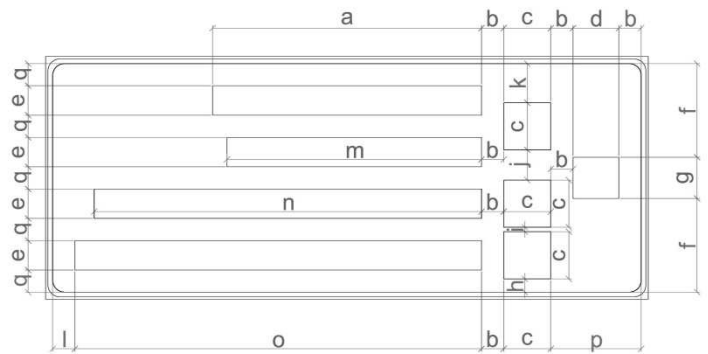

Fundo: Marrom
Tarja: Branco
Letra: Branco
Borda: Marrom
Pictograma: 200mm x 200mm
Seta: Tipo S3 / Cor: Branco

Contorno (mm)

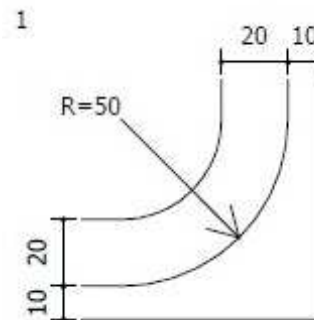

Fonte: Série E(m)
 Altura (mm): 125
 Cor: Branca
 Largura (mm): 1141

116	83	65	63	25	85	125	101
M	a	t	r	i	z		N
	31	36	40	30	40	0	0
25	101	70	25				
.	S	a	.				
	19	24	15				

Fonte: Série E(m)
 Altura (mm): 125
 Cor: Branca
 Largura (mm): 1080

83	83	125	101	25	83	83	83
d	a		P	i	e	d	a
	39	0	0	30	39	28	39
83	83						
d	e						
	39						

Fonte: Série E(m)
 Altura (mm): 125
 Cor: Branca
 Largura (mm): 1643

101	83	83	65	63	85	125	101
C	e	n	t	r	o		H
	24	39	36	40	19	0	43
25	83	65	85	63	25	83	85
i	s	t	ó	r	i	c	o
	36	25	29	39	30	39	28

Fonte: Série E(m)
 Altura (mm): 125
 Cor: Branca
 Largura (mm): 1725

93	83	63	25	101	83	83	65
T	u	r	.	G	a	s	t
	30	50	10	18	26	36	40
63	85	83	85	138	25	83	85
r	o	n	ô	m	i	c	o
	19	39	39	39	50	39	28

Placa – 69 (Suporte P57)



Status: Implementar
Dimensões: 2,45m x 1,35m



Tabela de cotas (mm):

a	b	c	d	e	f	g	h	i	j	k	l
88	195	200	609	175	125	1643	91	66	625	305	53,5

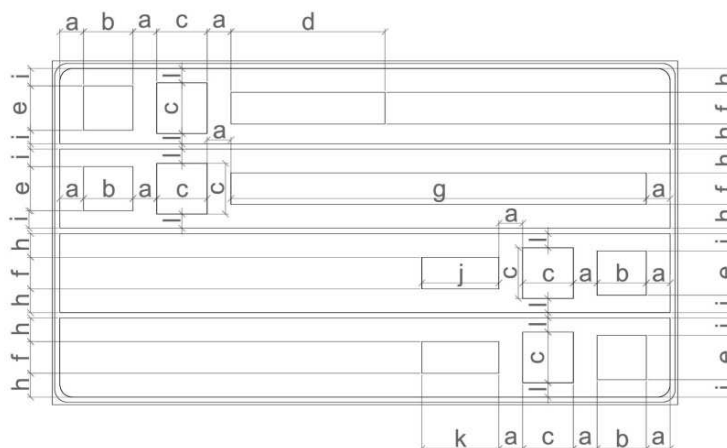

Fundo: Azul
Tarja: Branco
Letra: Branco
Borda: Azul
Pictograma: 200mm x 200mm

Seta: Tipo S1 / Cor: Branco



Fundo: Marrom
Tarja: Branco
Letra: Branco
Borda: Marrom
Pictograma: 200mm x 200mm

Seta: Tipo S1 / Cor: Branco



Fundo: Marrom
Tarja: Branco
Letra: Branco
Borda: Marrom
Pictograma: 200mm x 200mm

Seta: Tipo S1 / Cor: Branco



Fundo: Azul
Tarja: Branco
Letra: Branco
Borda: Azul
Pictograma: 200mm x 200mm

Seta: Tipo S1 / Cor: Branco

Contorno (mm)

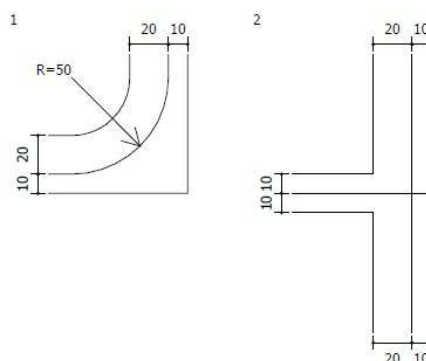

Fonte: Série E(m)
 Altura (mm): 125
 Cor: Branca
 Largura (mm): 609

101	83	83	85	63	65
R	e	s	o	r	t
	23	25	28	39	16

Fonte: Série E(m)
 Altura (mm): 125
 Cor: Branca
 Largura (mm): 1643

101	83	83	65	63	85	125	101	
C	e	n	t	r	o		H	
	24	39	36	40	19	0	0	43
25	83	65	85	63	25	83	85	
i	s	t	ó	r	i	c	o	
	36	25	29	39	30	39	28	

Fonte: Série E(m)
 Altura (mm): 125
 Cor: Branca
 Largura (mm): 625

101	83	63	63	83	83
S	e	r	r	a	s
	28	39	30	19	36

Fonte: Série D
 Altura (mm): 125
 Cor: Branca
 Largura (mm): 305

85	85	106
S	P	A
	21	8

Placa – 70 (Suporte P51)



Status: Implementar
Dimensões: 1,10m x 0,75m

Tabela de cotas (mm):

a	b	c	d	e	f	g	h
430	200	77,5	100	913	73,5	864	98

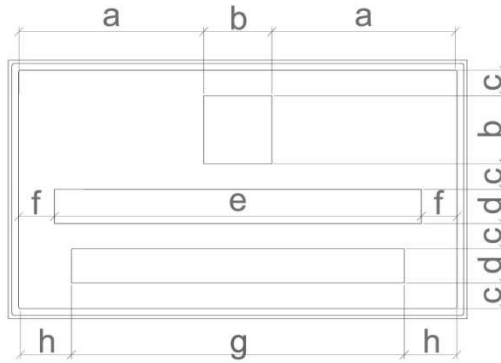

Fundo: Marrom
Tarja: Branco
Letra: Branco
Borda: Marrom
Pictograma: 200mm x 200mm

Contorno (mm)

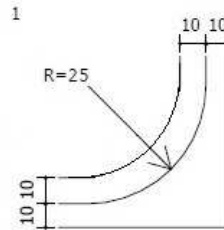

Fonte: Série E(m)

Altura (mm): 100

Cor: Branca

Largura (mm): 913

93	66	52	50	20	68	100	81	
M	a	t	r	i	z		N	
	25	29	32	24	32	0	0	18
20	81	56	20					
.	S	a	.					
	15	19	12					

Fonte: Série E(m)

Altura (mm): 100

Cor: Branca

Largura (mm): 864

66	66	100	81	20	66	66	66	
d	a		P	i	e	d	a	
	31	20	14	24	31	22	31	31
66	66							
d	e							
	31							

Placa – 71 (Suporte P55)



Status: Implementar
Dimensões: 1,40m x 0,35m



Tabela de cotas (mm):

a	b	c	d	e	f	g	h	i
89	195	200	609	175	67,5	92,5	125	55

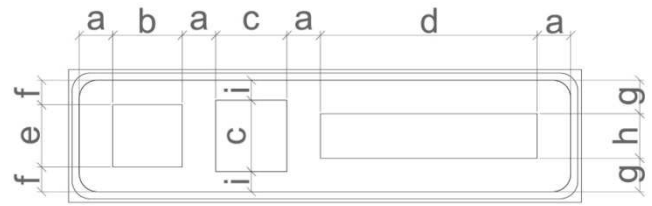

Fundo: Azul
Tarja: Branco
Letra: Branco
Borda: Azul
Pictograma: 200mm x 200mm

Seta: Tipo S1 / Cor: Branco

Contorno (mm)

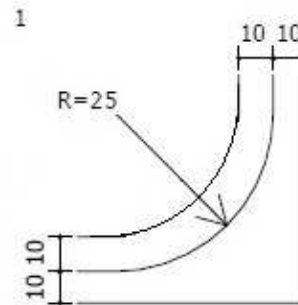

Fonte: Série E(m)

Altura (mm): 125

Cor: Branca

Largura (mm): 609

101	83	83	85	63	65
R	e	s	o	r	t
	23	25	28	39	16

Placa – 72 (Suporte P57)



Status: Implementar
Dimensões: 1,40m x 0,35m



Tabela de cotas (mm):

a	b	c	d	e	f	g	h	i
97	162	200	609	98	74	92,5	125	55

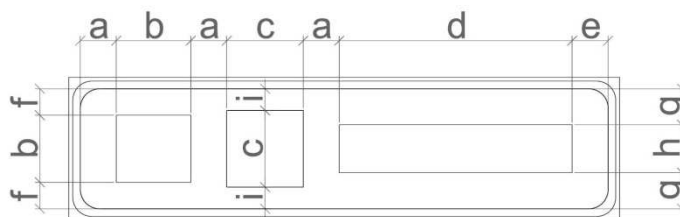

Fundo: Azul
Tarja: Branco
Letra: Branco
Borda: Azul
Pictograma: 200mm x 200mm

Seta: Tipo S1 / Cor: Branco

Contorno (mm)

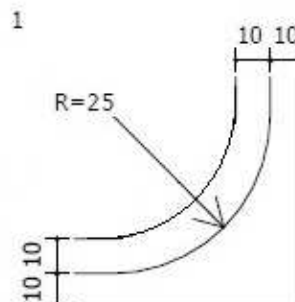

Fonte: Série E(m)

Altura (mm): 125

Cor: Branca

Largura (mm): 609

101	83	83	85	63	65
R	e	s	o	r	t
23	25	28	39	16	

Placa – 74 (Suporte P53m)

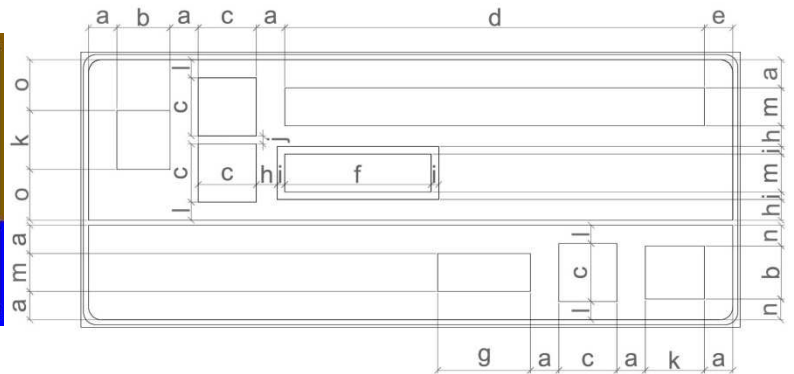

Status: Implementar
Dimensões: 2,95m x 1,10m

Tabela de cotas (mm):

a	b	c	d	e	f	g	h	i	j	k	l	m	n	o
114	210	230	1992	116	579	367	64	50	34	234	74	150	84	204



Fundo: Marrom
Tarja: Branco
Letra: Branco
Borda: Marrom
Pictograma: 230mm x 230mm

Seta: Tipo S2 / Cor: Branco



Fundo: Azul
Tarja: Branco
Letra: Branco
Borda: Azul
Pictograma: 230mm x 230mm



Fundo: Azul
Tarja: Branco
Letra: Branco
Borda: Azul
Pictograma: 230mm x 230mm

Seta: Tipo S1 / Cor: Branco

Contorno (mm)

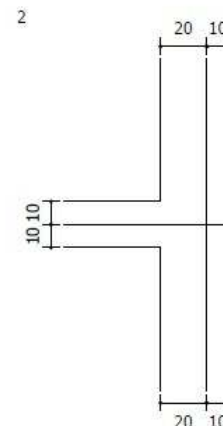
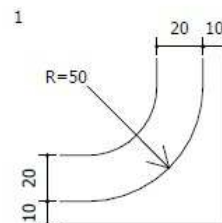

Fonte: Série E(m)

Altura (mm): 150

Cor: Branca

Largura (mm): 1992

111	99	75	30	150	99	99	150
T	u	r	.		d	e	
	36	60	12	0	0	47	0

122	99	99	102	99	30	102	99
N	e	g	o	c	i	o	s
	38	33	47	33	47	47	30

Fonte: Série E(m)

Altura (mm): 150

Cor: Branca

Largura (mm): 579

122	102	78	99	30
H	o	t	e	l
	38	30	35	47

Fonte: Série D

Altura (mm): 150

Cor: Branca

Largura (mm): 367

102	102	128
S	P	A
	26	9

Posicionamento

Detalhe da posição de implantação das placas

Nos mapas que seguem estão indicados locais e as posições das placas para implantação da Sinalização Turística de Cabreúva.

Na execução dos serviços deverá obedecer rigorosamente os projetos, instruções e prazos a serem fornecidos, bem como as demais disposições de Contrato e da presente Especificação Técnica.

Os padrões de sinalização são estabelecidos pelo Manual Brasileiro de Sinalização de Trânsito do CONTRAN (Conselho Nacional de Trânsito) – Volume III em consonância com CTB (Código de Trânsito Brasileiro) e Resolução do CONTRAN nº. 160/04, e manuais DER/SP (Departamento de Estrada de Rodagem)

Posição placas 1, 2, 3, 5, 6, 7, 8, 9 e 11

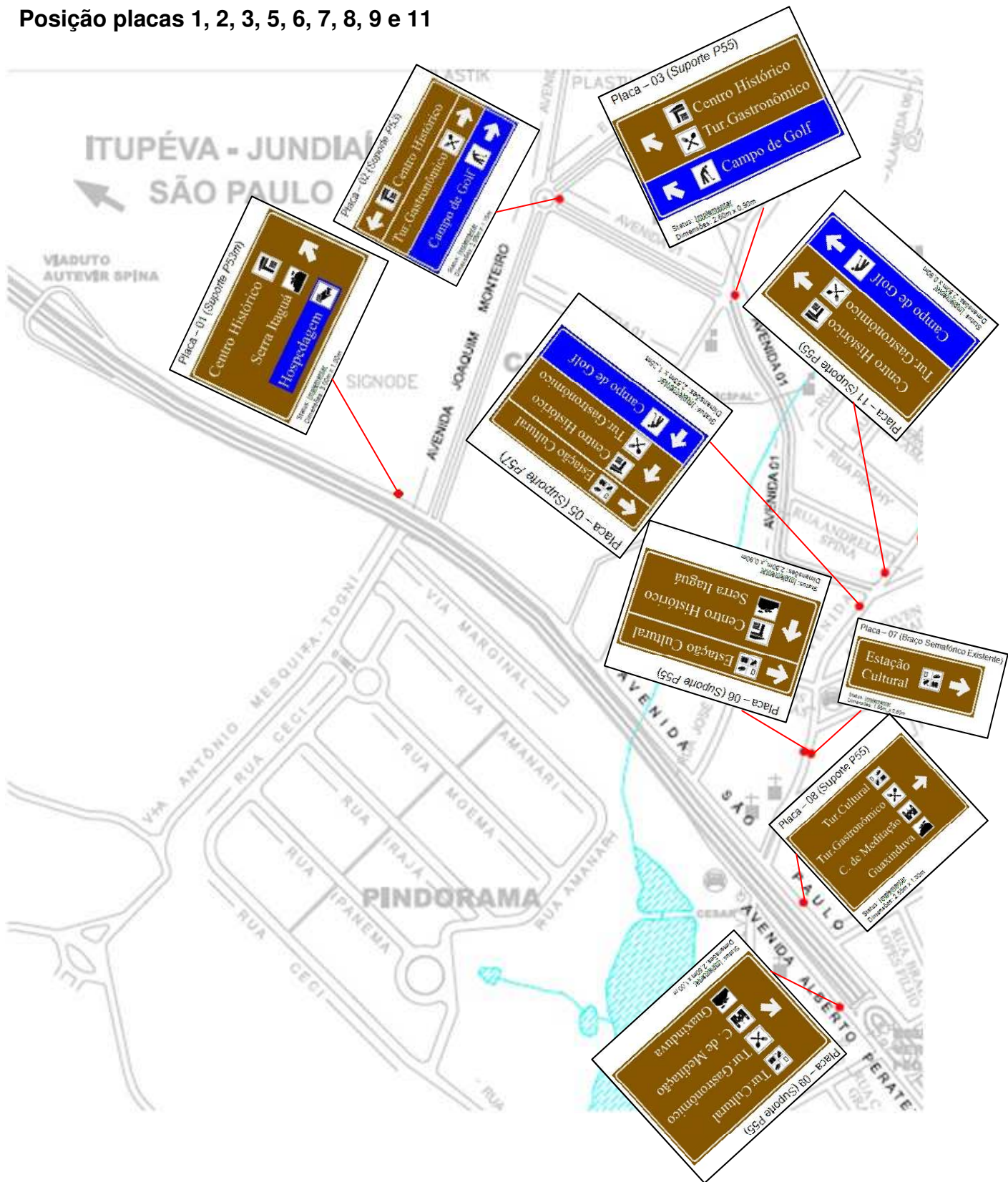

Posição placa 10



Posição placas 4, 12, 13, 14, 15, 16, 17, 18, 19, 20 e 21

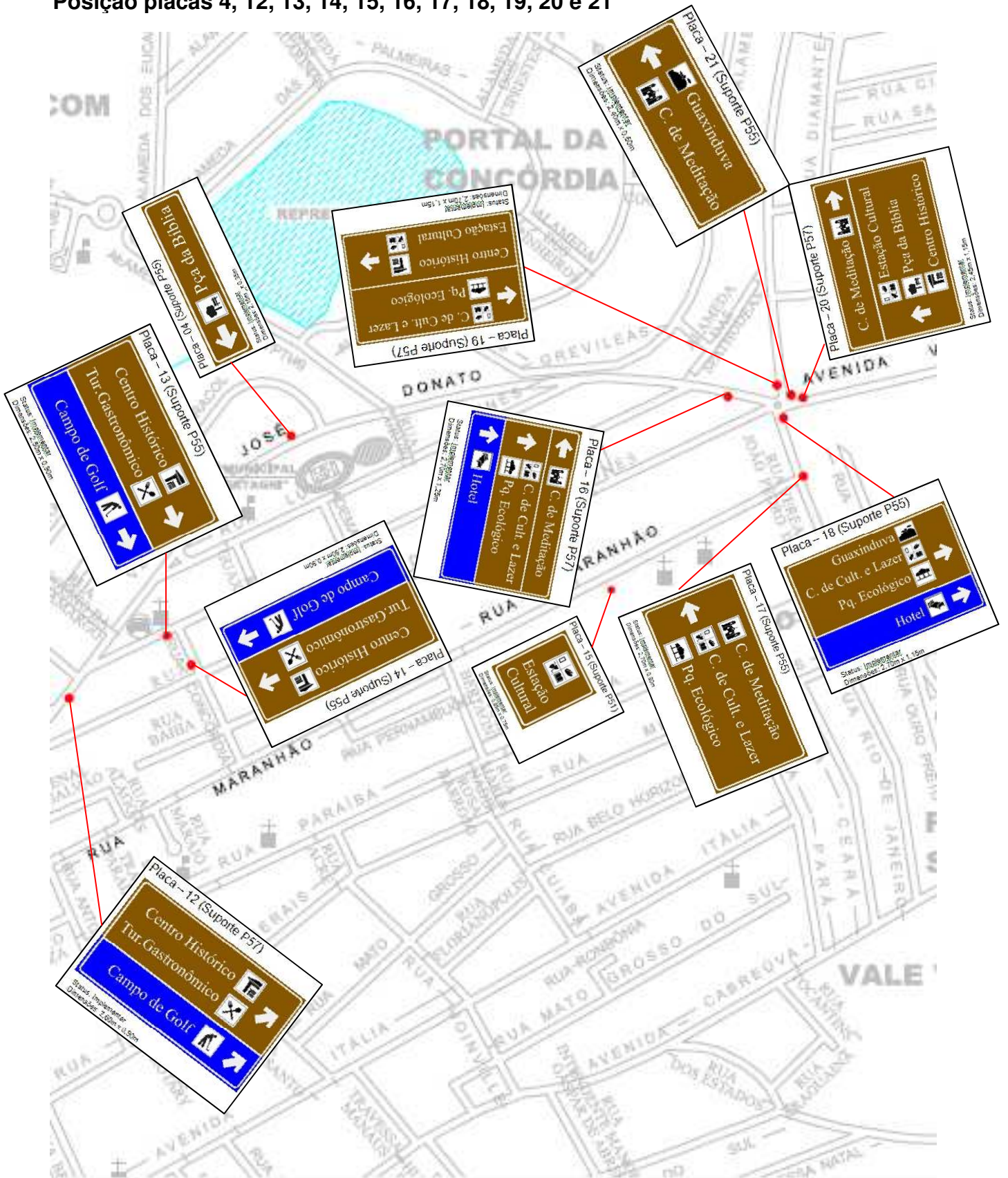

Posição placas 22, 23, 24, 25, 26, 27, 28 e 29

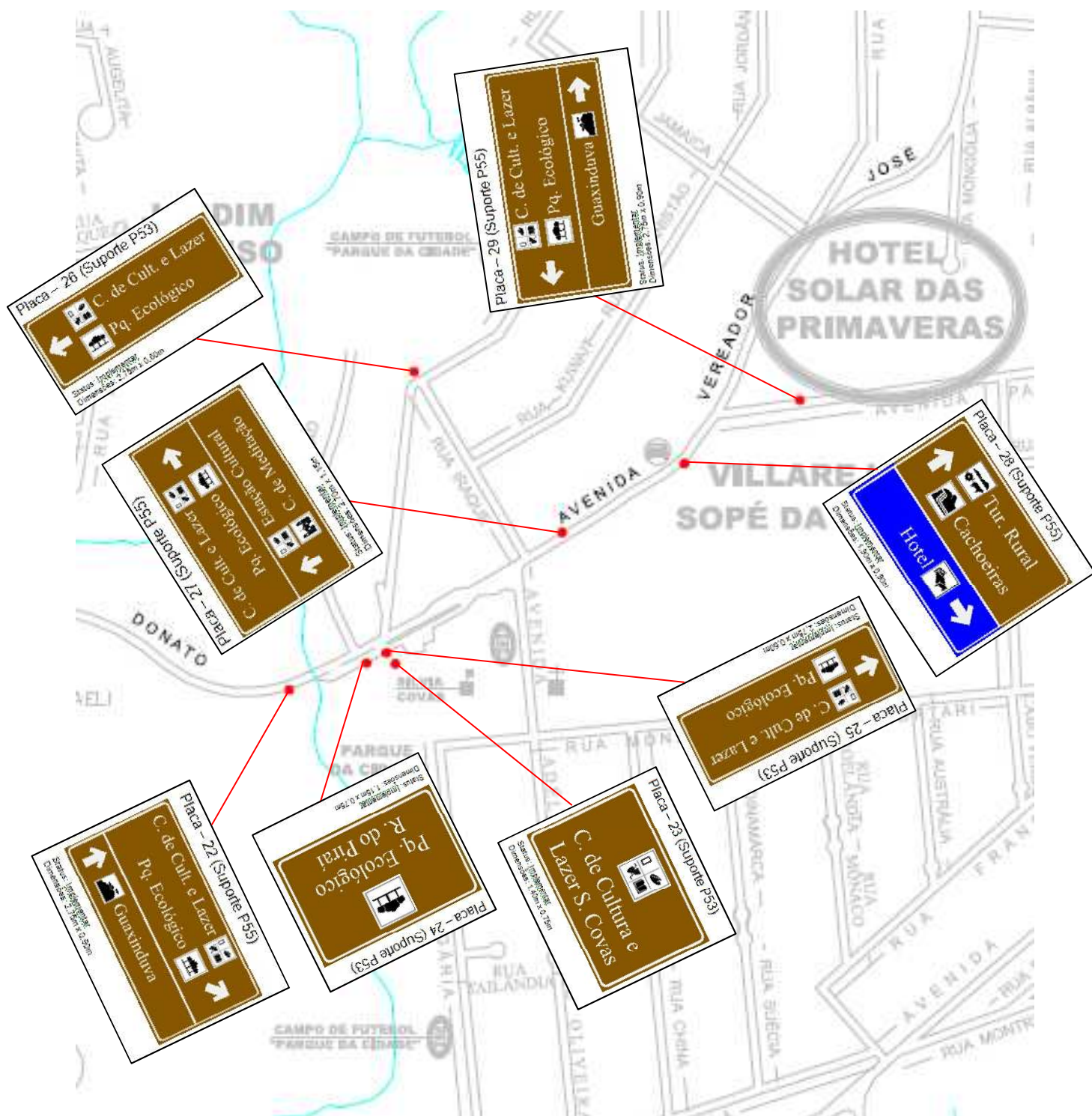

Posição placas 30, 31 e 32

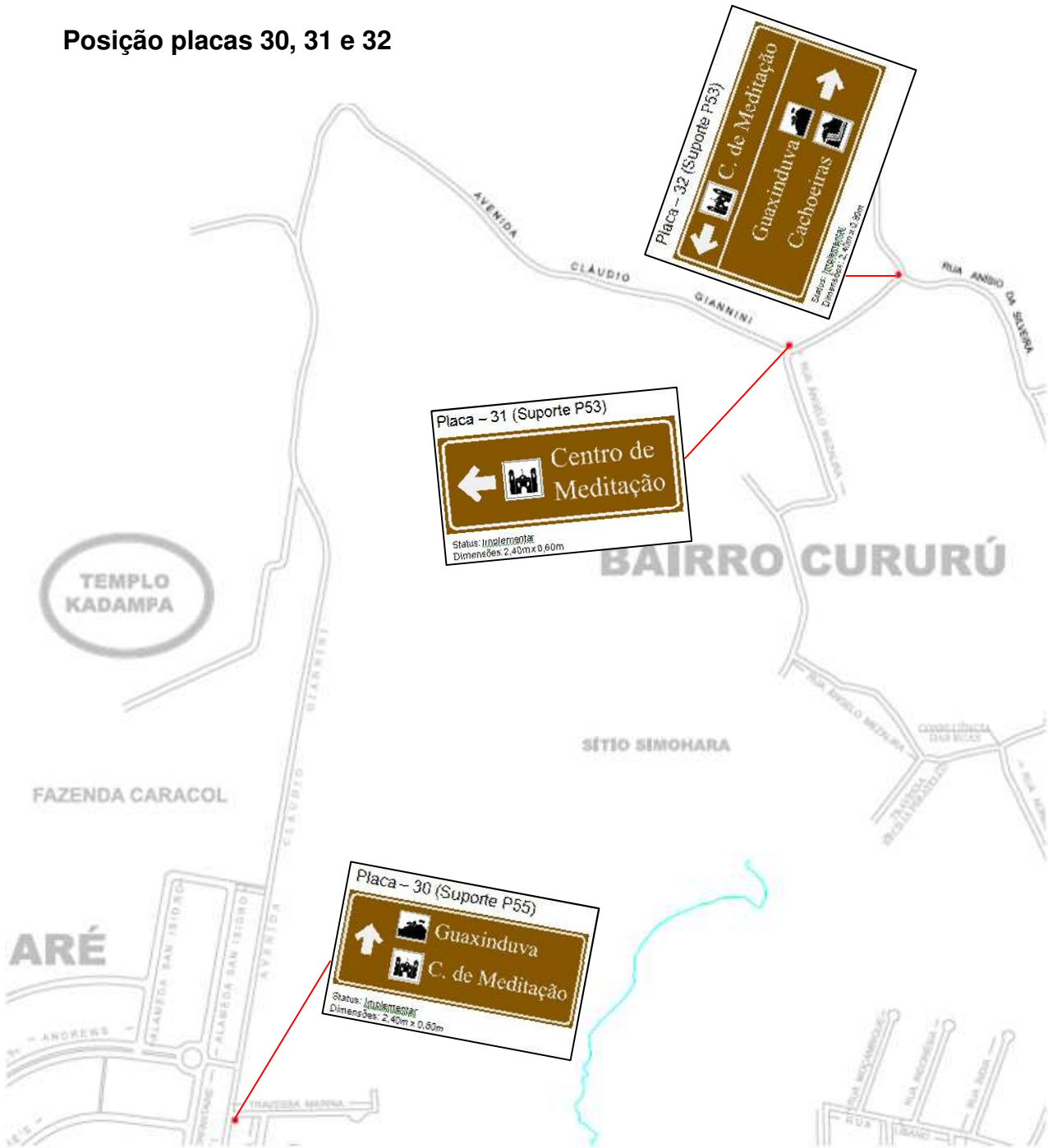

Posição placas 33, 34, 35 e 36

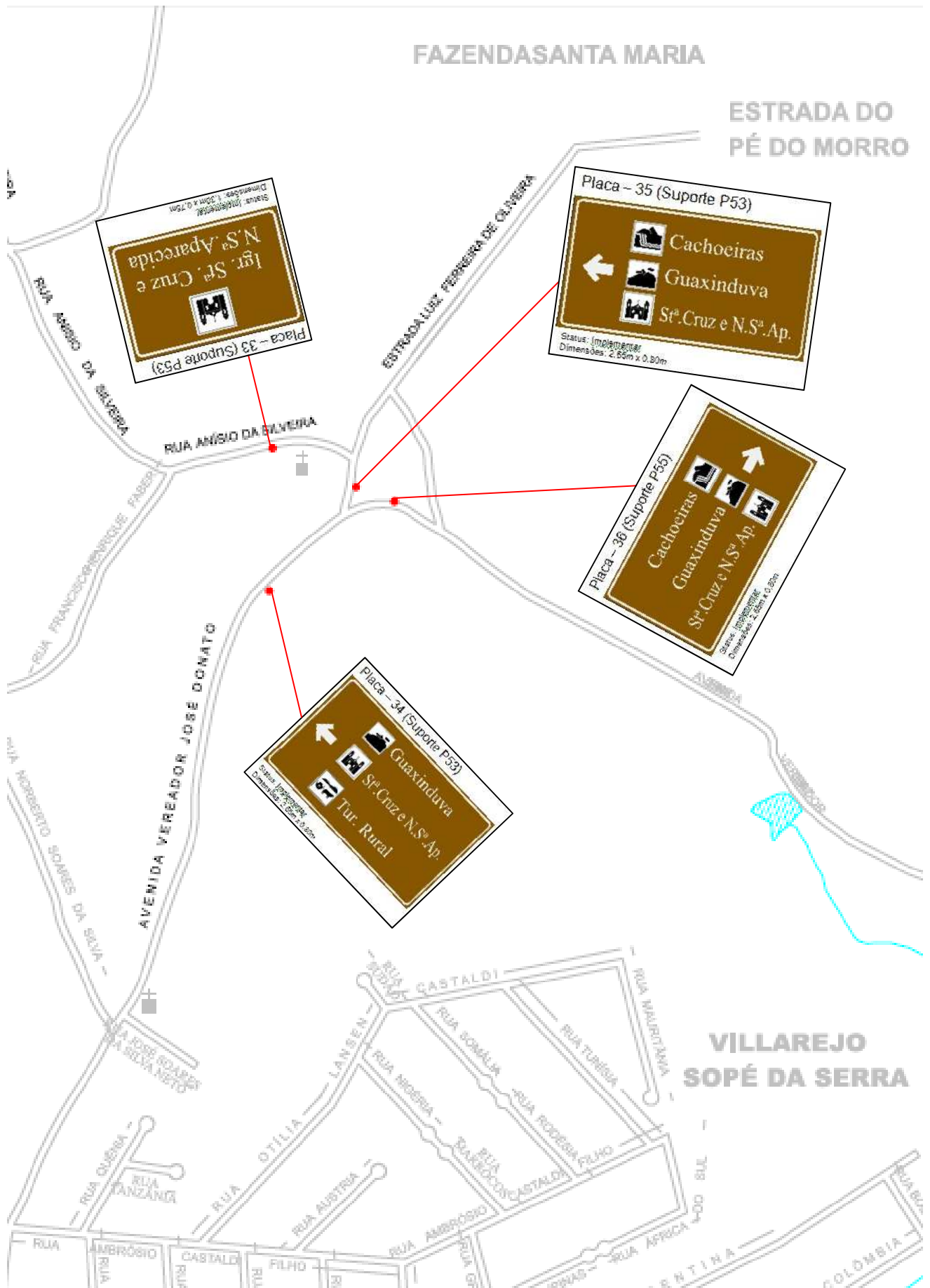

Posição placas 37, 38, 39, 40 e 41

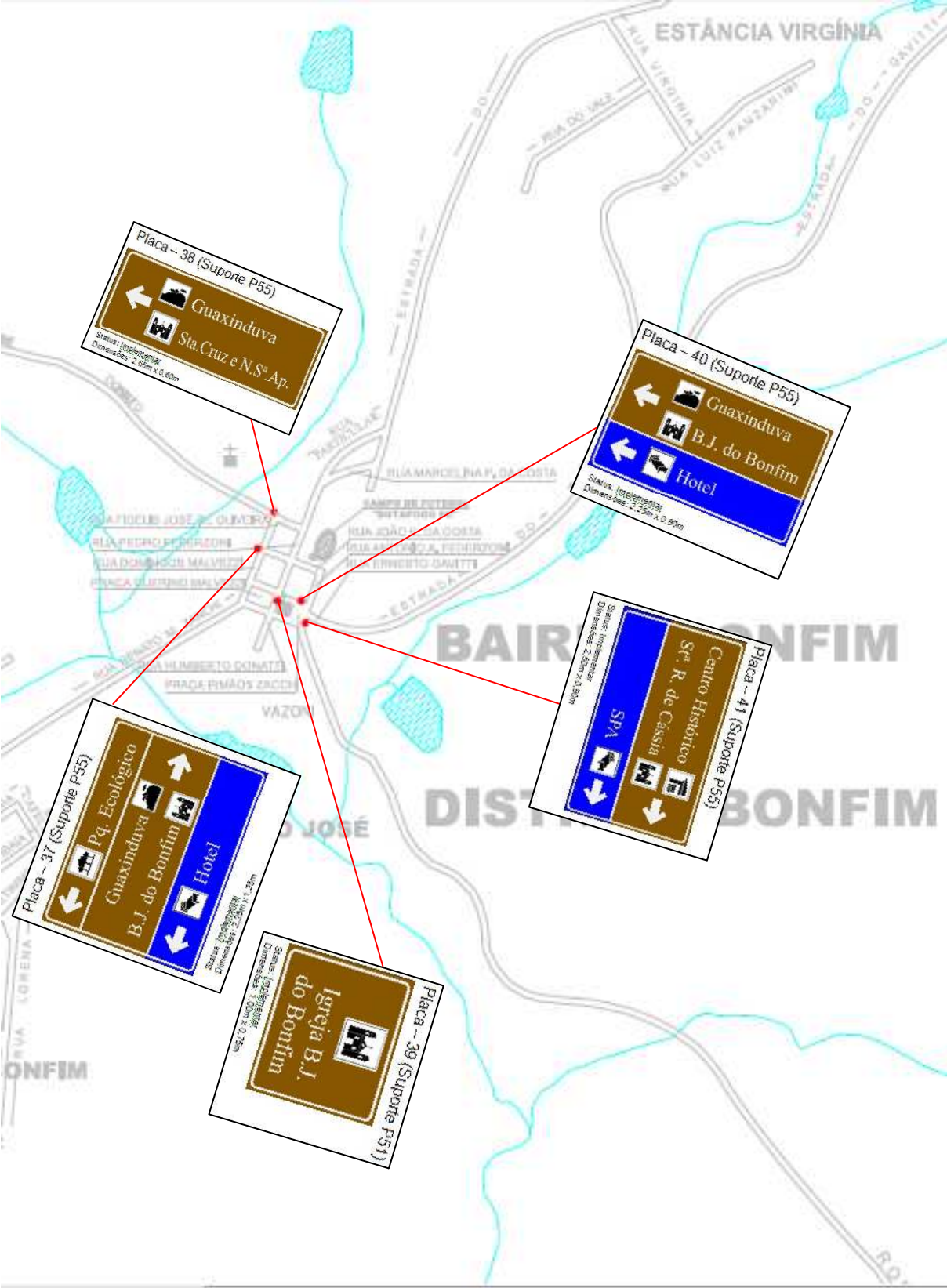

Posição placa 42

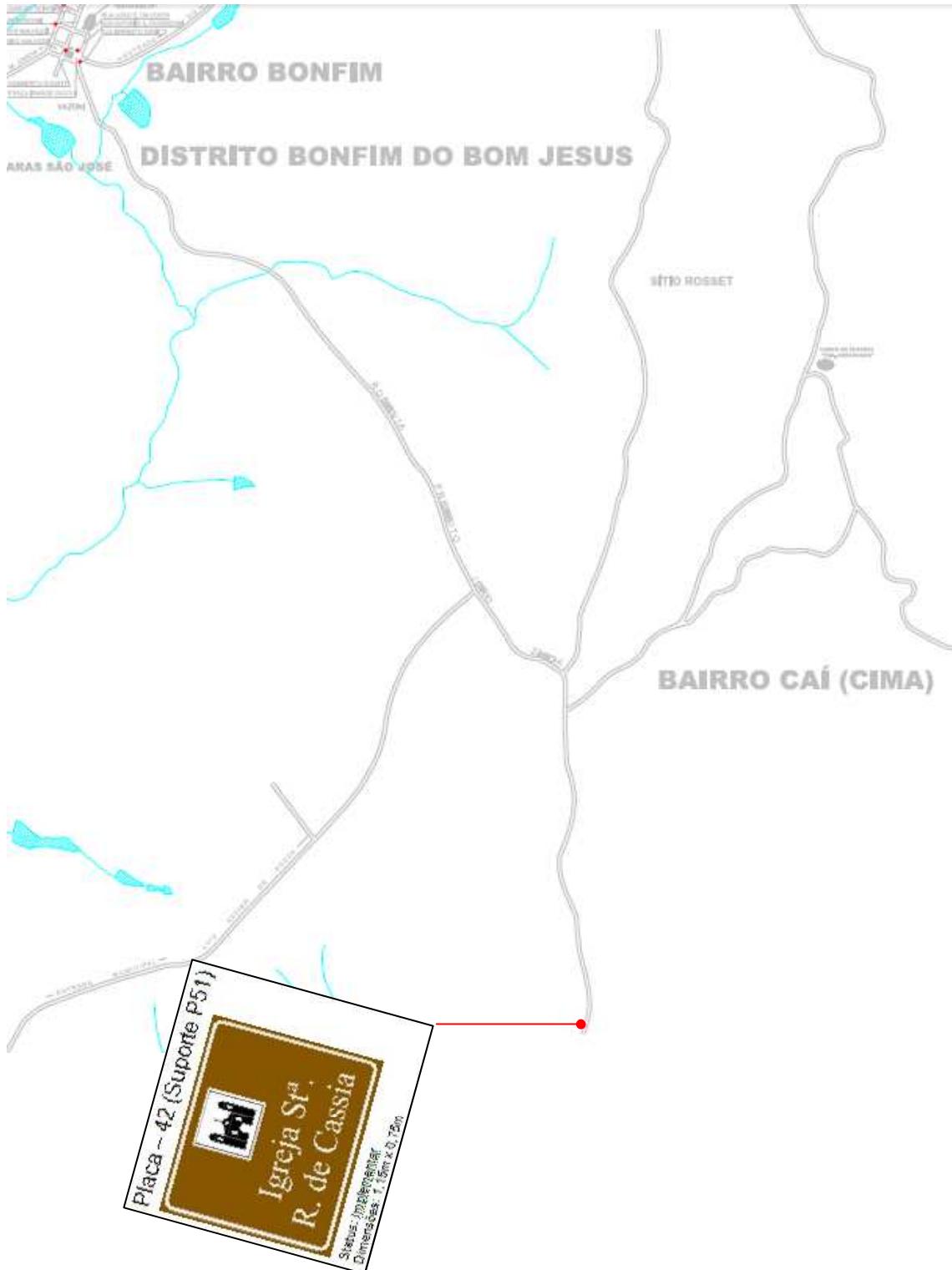

Posição placas 43, 44, 45, 46, 48, 49 e 50

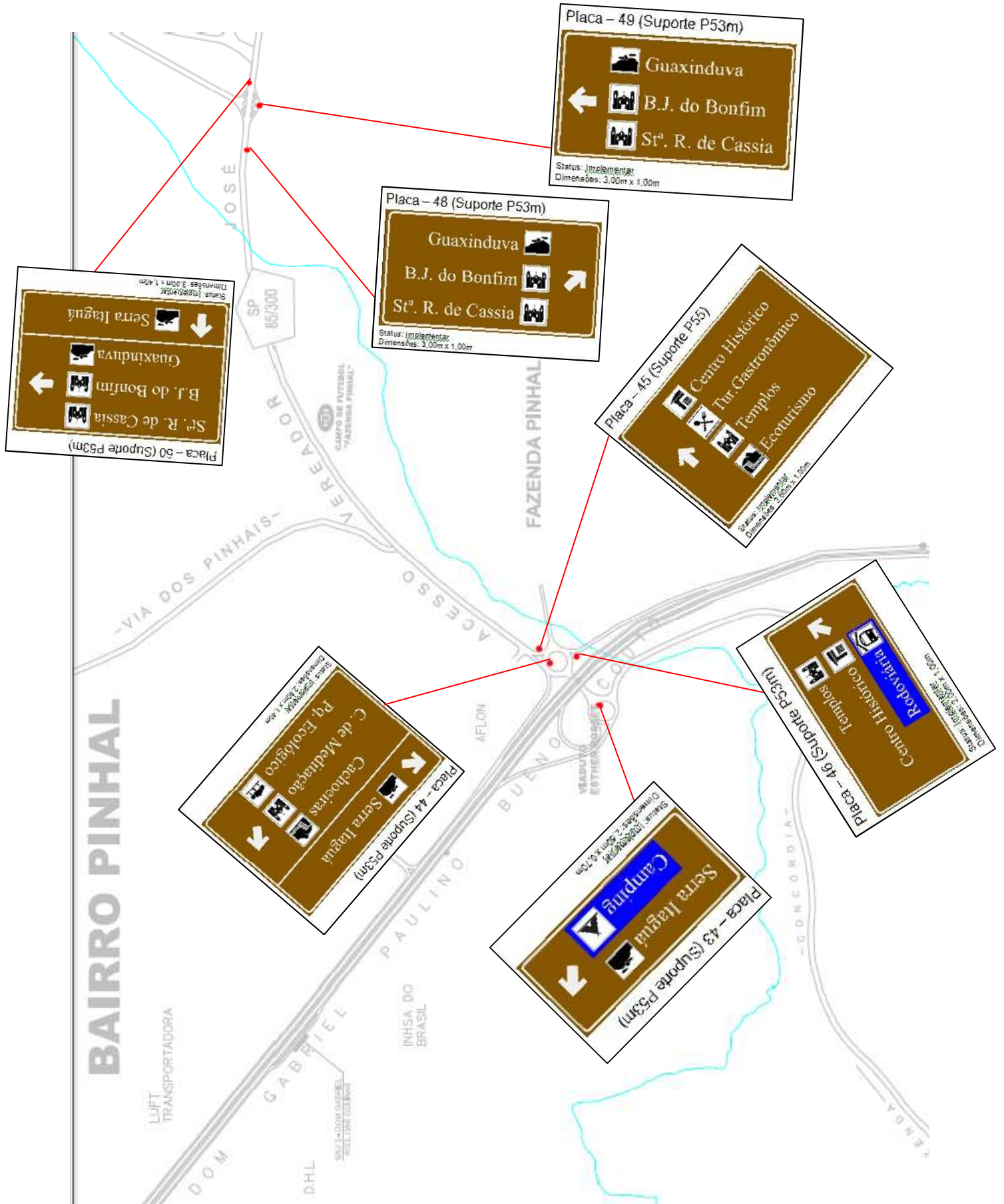

Posição placas 51, 52, 53, 54, 55, 56, 57, 59 e 69

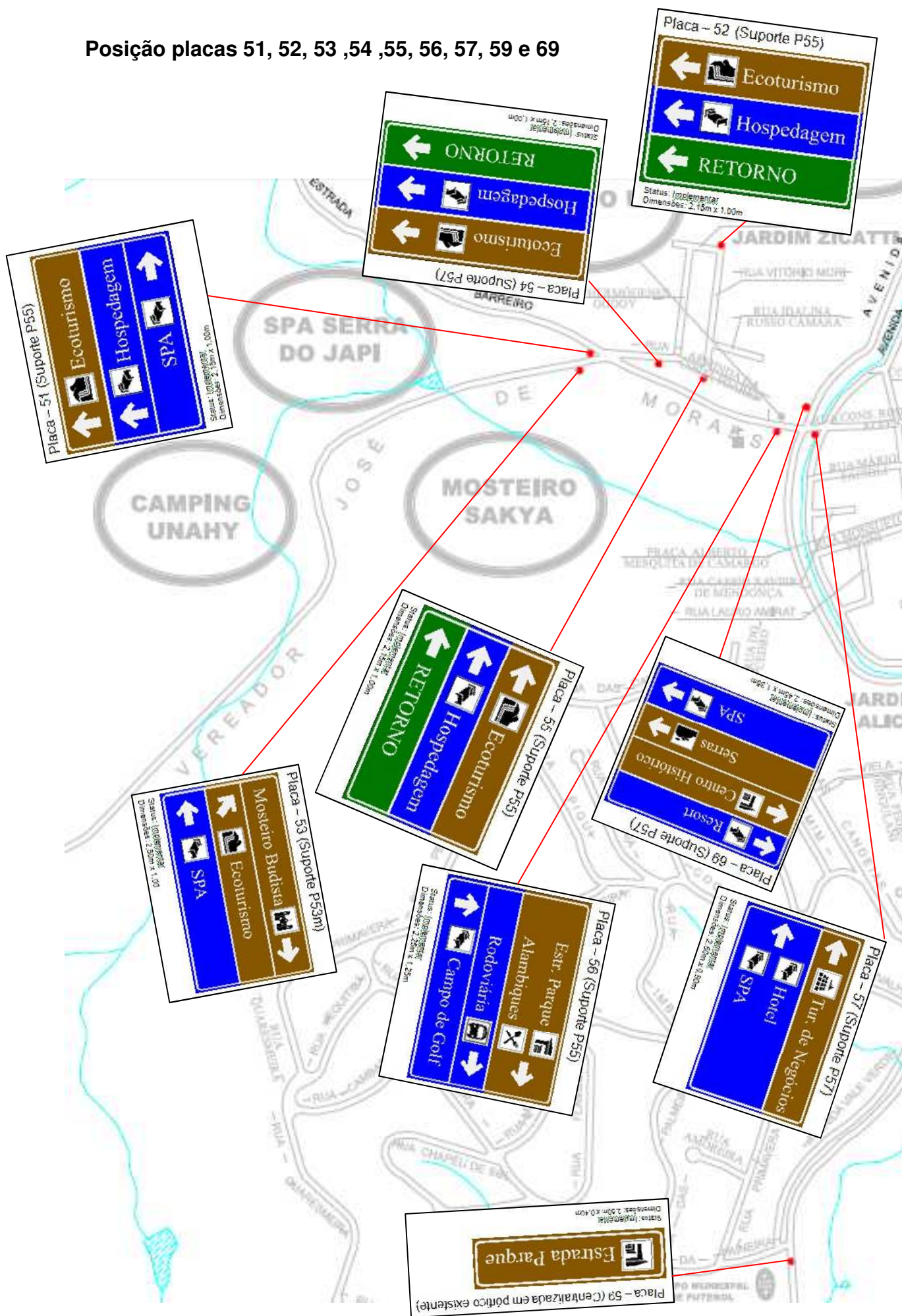

Posição placas 58, 60, 61, 62, 63, 64, 65, 66, 67, 68, 70 e 71

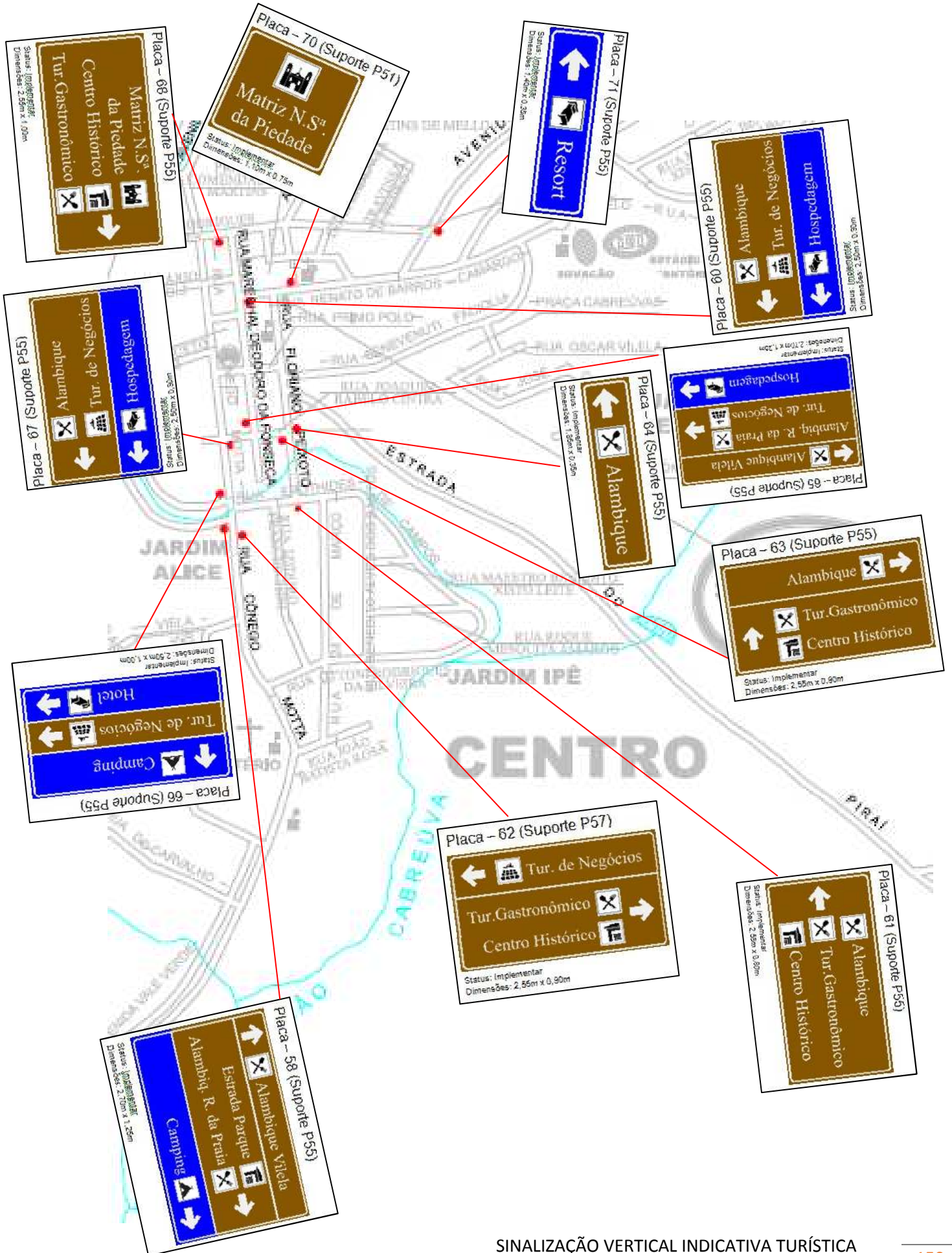

Posição placas 72, 73 e 74

